

# WZ 1000 Water Timer Manual

Please read the manual carefully and familiarize yourself with the functions of the unit before using it. Retain these instructions for future reference and pass them on together with the device when you pass on the device to other users.

## Scope of delivery:

- 1 Irrigation controller
- 1 Coupling
- 1 Adapter 33.3 mm to 26.5 mm (G1 "to G"3/4)
- 1 Filter
- 1 Instruction manual

## Product Overview

Fig. A:

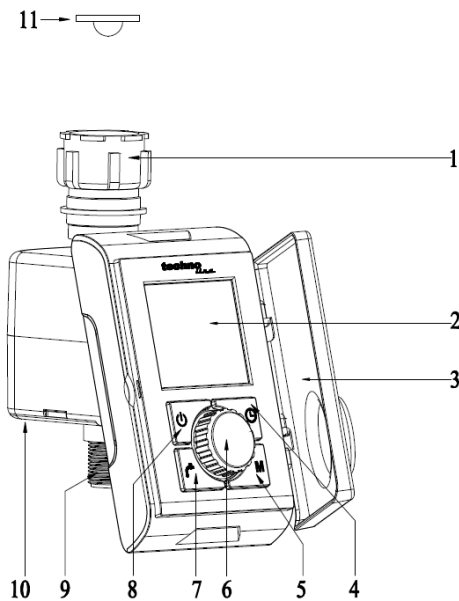

Fig. B:

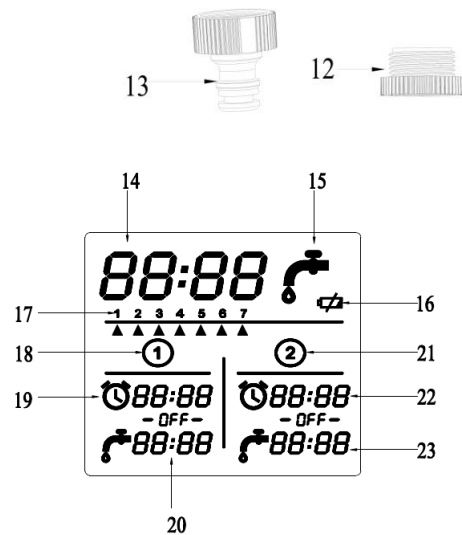
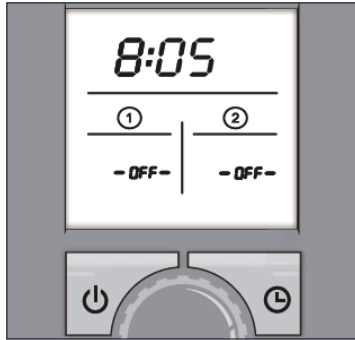





Fig. C:



### Parts description (Fig. A)

- 1 Union nut (for tap connector)
- 2 Display
- 3 Protective cover
- 4 Button 
- 5 Button **M**
- 6 Rotary control
- 7 Button 
- 8 Button  (ON / OFF)
- 9 Hose connection
- 10 Battery compartment
- 11 Filter
- 12 Adapter 33.3 mm to 26.5 mm (G1" to

G"3/4)

13 Coupling

### Display indicators (Fig. B)

- 14 System time
- 15 Irrigation / manual irrigation
- 16 Battery status
- 17 Irrigation interval
- 18 Irrigation 1
- 19 Start time irrigation 1
- 20 Duration irrigation 1
- 21 Irrigation 2
- 22 Start time irrigation 2
- 23 Duration irrigation

### General safety information

This unit can be used by children aged 8 years and above and persons with reduced physical, sensory or mental capabilities or lack of experience and knowledge if they are supervised and have been instructed concerning the safe use of the appliance and have understood the resulting risks. Children should never play with the device. Cleaning and user maintenance must not be performed by children without supervision.

## **Intended Use**

This product is designed to control sprinklers and sprinkler and irrigation systems. It facilitates the automatic irrigation of outdoor areas at a programmed time and for a programmed duration. The product may save up to 2 programmes for automatic irrigation. The product may only be used outdoors. Any other use or modification to the product constitutes improper use. The manufacturer assumes no liability for damages due to improper use. This product is not intended for commercial use.

## **Inserting / replacing batteries**

- Open the battery compartment (10).
- Insert 2 AA batteries (LR06 / Mignon) into the battery compartment (10). When doing so, pay attention to the polarity markings on the batteries and in the battery compartment (10).
- Close the battery compartment (10).
- The display (2) will switch on automatically and the system time will begin at 0:00.

**Attention!** After inserting batteries, please make sure the battery door is firmly closed without gap. If the battery is not closed firmly, will cause the water leakage to battery compartment and unit malfunction!!!

## **Initial use**

The site where the product will be installed must meet the following requirements for safe and trouble-free operation:

- The maximum temperature of the flowing water is 40 °C.
- The minimum operating temperature is +5 °C.
- Only use clear freshwater.
- Only connect the product vertically with the hose connection 9 pointed downwards to prevent water from entering the battery compartment (10).

**Attention!** The irrigation controller may only be connected to a drinking water abstraction point with a safety device which corresponds to TYPE HD at the very least according to EN 1717 (backflow preventer with tube ventilation).

**Note:** Such mains adapters are available from speciality retailers.

- Check the water connection type available. The product is fitted with a union nut (1) for a

tap with a 33.3 mm thread (G 1"). For a tap with a 26.5 mm thread (G 3/4") use the adapter supplied (12).

- Insert the filter (11) into the union nut 1 as depicted in Figure A.
- For a 26.5 mm thread (G 3/4"): Screw the adapter (12) onto the tap. Do not use any tools for this purpose.
- Screw the union nut (1) onto the thread of the tap or the adapter. Do not use any tools for this purpose.
- Screw the coupling (13) onto the hose connection (9). You can then connect a hose to the coupling (13).
- Open the tap.

**Attention!** If defects / leaks arise when using the adapter (12), the thread of the tap must be wrapped using sealing tape.

- Open the protective cover to service the product (3). Close the protective cover (3) fully afterwards.
- Programme irrigation as described in the chapter "Operation".

## **Operation**

Irrigation can be fully automated at any time of the day using the irrigation controller. A sprinkler, sprinkler system or drip irrigation system may be connected. The irrigation controller automatically carries out irrigation at the respective programmed start time and for the programmed duration. Take the season and time of the day into consideration when programming. Evaporation and water consumption is lowest early in the morning or late in the evening.



### **Switching the product on / off (Fig. 1)**

Press and hold down the ON / OFF button (8) for approx. 2 seconds to switch it on or off.

Note: Automatic irrigation does not occur if the product is switched off (see Fig. C). In a switched-off state, however, irrigation may occur manually (as described in the chapter "Manual irrigation. ").

### **Adjusting the time (Fig. 2–6)**

1. Switch on the product. Press and hold down the  ON / OFF button (8) for approx. 2 seconds.

2. Press and hold down the  button (4) for approx. 2 seconds. The system time's hour display will flash.
3. Set the hour by turning the rotary control (6).
4. Press the  button (4). The system time's minute display will flash.
5. Set the minutes by turning the rotary control (6).
6. Then press the  button (4) again to save.

### **Programme irrigation 1 and 2, interval (Fig. 7–29)**

Press and hold down the **M** button (5) for approx. 2 seconds to activate programming mode. You can either apply all settings one after the other, or switch between the following setting options by repeatedly pressing the **M** button (5):

Start time irrigation 1

Duration irrigation 1

Start time irrigation 2

Duration irrigation 2

Irrigation interval (1 = every day, 2 = every 2<sup>nd</sup> day, etc.)

Standby (programming mode ended and automatic irrigation activated)

- Press the **M** button (5) again in programming mode. The hour display for start time irrigation 1 will flash. Set the hours by turning the rotary control (6).
- Press the **M** button (5) again. The minute display for start time irrigation 1 will flash. Set the minutes by turning the rotary control (6).
- Press the **M** button (5) again. The hour display for irrigation duration 2 will flash. Set the hours by turning the rotary control (6).
- Press the **M** button (5) again. The minute display duration for irrigation 2 will flash. Set the minutes by turning the rotary control (6).

**Note:** Please note that you programme the duration of irrigation, not the end time!

Here are some examples for possible settings /duration of irrigation:

0:05 = 5 minutes

00:45 = 45 minutes

2:15 = 2 hours and 15 minutes

Set the value to „00:00“ or the previous „--:--“ and the irrigation interval will not be triggered, until new values will be set.

Avoid overlapping irrigation times.

The minimum irrigation duration amounts to 1 minute.



The maximum irrigation duration amounts to 23 hours and 59 minutes.

- Press the **M** button (5) again. The arrow display for the irrigation interval will flash.  
Set the interval by turning the rotary control (6) (1 = every day, 2 = every 2nd day etc.).
- Press the **M** button (5) again. The product will switch to standby mode. Irrigation will start automatically at the programmed time. During the duration of irrigation the  display behind the system time and duration of irrigation ((20) or (23)) will flash.

**Note:** By briefly pressing the  button (8) you can jump back a step in programming mode to change the programmed values.

**Note:** After approx. 1 minute without an entry, the product will return to standby mode. All values which have already been programmed will be retained.

### Manual irrigation (Fig. 30–36)

- Press and hold down the  button (7) for approx. 2 seconds. Manual irrigation begins as soon as the  display flashes behind the system time.
- To adjust the manual irrigation time press the **M** button (5). The hour display will flash.

Set the hours by turning the rotary control (6).

- Press the **M** button (5) again. The minute display will flash. Set the minutes by turning the rotary control (6).
- Press the **M** button (5) again to confirm your entry.

The set duration for manual irrigation is saved and will be automatically adopted for the next manual irrigation.

- To prematurely end manual irrigation, press the  ON / OFF button (8)

### **Battery status display**

The  display (16) flashes if the battery is weak or empty. All other displays are deactivated.

- Change the batteries as described in the chapter “Inserting / changing the batteries“.

**Note:** If the  display (16) flashes, irrigation is not possible. Irrigation which may be occurring will be interrupted.

Programming will be saved for 2 minutes. If changing the batteries takes longer, all settings must be selected again.

### **Troubleshooting**

This product contains delicate electronic components. For this reason, it may be disrupted by transmissions from transmitters in the direct vicinity.

**Note:** Electrostatic discharge can cause malfunctions. If this happens, briefly remove the batteries from the battery compartment 10 and reinsert them again after 10 minutes. The product will be fully reset. The product will then be ready for use again.

**Note:** Please note that all settings will be deleted if the product is reset.

| Error | Possible Cause | Solution |
|-------|----------------|----------|
|-------|----------------|----------|

|                                 |  |   |
|---------------------------------|--|---|
| No notifications on the display | No batteries inserted                    | Insert batteries  |
|                                 | The batteries are dead                   | Replace the batteries   |
|                                 | Water leakage to the battery compartment | Remove batteries, use a slightly damp cloth to clean the water inside battery compartment and insert battery again or replace new batteries |
| Irrigation will not start       | The tap is closed                        | Open the tap  |
|                                 | Wrong programming                        | Check the programming   |
|                                 | No batteries or dead batteries           | Insert batteries or replace the batteries   |

## **Cleaning and Care**

**Attention!** Potential damage to the product.

Moisture entering the product may result in damage. Ensure no moisture enters the battery compartment (10) during cleaning to prevent damaging the product beyond repair.

- Only clean the housing with a slightly damp cloth and mild washing-up liquid.
- Never use petrol, alcohol or other aggressive cleaning agents to clean the housing.

### **Cleaning the filter**

- The filter (11) must be regularly checked and cleaned if necessary.
- Close the tap.
- Allow the product to run dry by manual irrigation.
- Unscrew the union nut (1) from the tap or adapter thread.
- Remove the conical filter from the water inlet in the union nut.
- Clean the filter.
- Reinsert the filter.
- Screw the union nut onto the thread of the tap or adapter.
- Open the tap.



## **Storage**

- Close the tap.
- Loosen the hose from the coupling (13).
- Allow the product to run dry.
- Loosen the union nut (1).
- Remove the batteries.
- Store the product in a dry and frost-free environment.

## **Technical Data**

Model No.: WZ 1000

Operating pressure: 34.5–827 kPa (0.34–8.27 bar)

Max. water temperature: 40°C

Power supply: 2 x 1.5 V (direct current) Batteries Type AA

Flow rate: approx. 28 l / min

Programmable Irrigation time: 1 min–1439 min

Manual Irrigation time: 1 min–1439 min

Water connection: G 3/4 (26.5 mm) or G 1" (33.3 mm)

Protection class: IP X4 (splash-proof)

## **Precautions**

- Do not subject the unit to excessive force or shock.
- Do not expose the unit to extreme temperatures, direct sunlight, dust or humidity.
- Do not immerse in water.
- Avoid contact with any corrosive materials.
- Do not dispose this unit in a fire as it may explode.
- Do not open the inner back case or tamper with any components of this unit.

## **Batteries safety warnings**

- Don't use rechargeable batteries.
- Install batteries correctly by matching the polarities (+/-).
- Always replace a complete set of batteries.
- Never mix used and new batteries.
- Remove exhausted batteries immediately.
- Remove batteries when not in use.
- Do not recharge and do not dispose of batteries in fire as the batteries may explode.
- Ensure batteries are stored away from metal objects as contact may cause a short circuit.
- Avoid exposing batteries to extreme temperature or humidity or direct sunlight.

- Keep all batteries out of reach from children. They are a choking hazard.

Use the product only for its intended purpose!

#### **Consideration of duty according to the battery law**



**Old batteries do not belong to domestic waste because they could cause damages of health and environment. You can return used batteries free of charge to your dealer and collection points. As end-user you are committed by law to bring back needed batteries to distributors and other collecting points!**

#### **Consideration of duty according to the law of electrical devices**



**This symbol means that you must dispose of electrical devices separated from the General household waste when it reaches the end of its useful life. Take your unit to your local waste collection point or recycling centre. This applies to all countries of the European Union, and to other European countries with a separate waste collection system.**