



■ Features

- Constant Voltage + Constant Current mode output
- Plastic housing with Class II design
- Built-in active PFC function
- Class 2 power unit
- Fully encapsulated with IP30 level, optional IP67 rating
- Typical lifetime > 50000 hours
- 5 years warranty

■ Applications

- LED downlight
- LED spotlight
- LED decorative lighting
- LED tunnel lighting

■ Description

LPF-16 series is a 16W AC/DC LED driver featuring the dual modes constant voltage and constant current output. LPF-16 operates from 90~305VAC and offers models with different rated voltage ranging between 12V and 54V. Thanks to the efficiency up to 86%, with the fanless design, the entire series is able to operate for -35°C ~ +70°C case temperature under free air convection. The entire series is suitable to work for a variety of applications at dry or damp locations and the optional models with IP67 rating is able to further work at wet locations.

■ Model Encoding

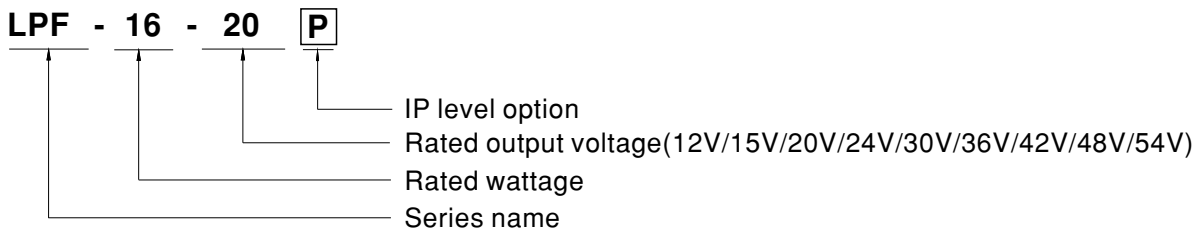

| Type | IP Level | Note |
|-------|----------|------------|
| Blank | IP30 | In Stock |
| P | IP67 | By request |



SPECIFICATION

| MODEL | LPF-16-12 | LPF-16-15 | LPF-16-20 | LPF-16-24 | LPF-16-30 | LPF-16-36 | LPF-16-42 | LPF-16-48 | LPF-16-54 | |
|---------------------|---|---|------------|-----------|------------|------------|------------|------------|------------|------------|
| OUTPUT | DC VOLTAGE | 12V | 15V | 20V | 24V | 30V | 36V | 42V | 48V | 54V |
| | CONSTANT CURRENT REGION <small>Note.2</small> | 6.6 ~ 12V | 8.25 ~ 15V | 11 ~ 20V | 13.2 ~ 24V | 16.5 ~ 30V | 19.8 ~ 36V | 23.1 ~ 42V | 26.4 ~ 48V | 29.7 ~ 54V |
| | RATED CURRENT | 1.34A | 1.07A | 0.8A | 0.67A | 0.54A | 0.45A | 0.39A | 0.34A | 0.3A |
| | RATED POWER <small>Note.5</small> | 16.08W | 16.05W | 16W | 16.08W | 16.2W | 16.2W | 16.38W | 16.32W | 16.2W |
| | RIPPLE & NOISE (max.) <small>Note.3</small> | 150mVp-p | 150mVp-p | 150mVp-p | 150mVp-p | 200mVp-p | 250mVp-p | 250mVp-p | 250mVp-p | 350mVp-p |
| | VOLTAGE TOLERANCE <small>Note.4</small> | ±4.0% | ±4.0% | ±4.0% | ±4.0% | ±4.0% | ±4.0% | ±4.0% | ±4.0% | ±4.0% |
| | LINE REGULATION | ±0.5% | ±0.5% | ±0.5% | ±0.5% | ±0.5% | ±0.5% | ±0.5% | ±0.5% | ±0.5% |
| | LOAD REGULATION | ±2.0% | ±1.5% | ±1.0% | ±0.5% | ±0.5% | ±0.5% | ±0.5% | ±0.5% | ±0.5% |
| | SETUP, RISE TIME <small>Note.6</small> | 1500ms, 80ms / 115VAC 500ms, 80ms / 230VAC | | | | | | | | |
| HOLD UP TIME (Typ.) | 16ms/230VAC 16ms /115VAC | | | | | | | | | |
| INPUT | VOLTAGE RANGE <small>Note.5</small> | 90 ~ 305VAC 127 ~ 431VDC (Please refer to "STATIC CHARACTERISTIC" section) | | | | | | | | |
| | FREQUENCY RANGE | 47 ~ 63Hz | | | | | | | | |
| | POWER FACTOR | PF ≥ 0.97/115VAC, PF ≥ 0.95/230VAC, PF ≥ 0.92/277VAC@full load (Please refer to "POWER FACTOR (PF) CHARACTERISTIC" section) | | | | | | | | |
| | TOTAL HARMONIC DISTORTION | THD < 20% (@load ≥ 60%/115VAC, 230VAC; @load ≥ 75%/277VAC) (Please refer to "TOTAL HARMONIC DISTORTION(THD)" section) | | | | | | | | |
| | EFFICIENCY (Typ.) | 84% | 84% | 86% | 86% | 86% | 86% | 86% | 86% | 86% |
| | AC CURRENT | 0.4A / 115VAC 0.25A / 230VAC 0.2A/277VAC | | | | | | | | |
| | INRUSH CURRENT(Typ.) | COLD START 45A(twidth=200µs measured at 50% Ipeak) at 230VAC; Per NEMA 410 | | | | | | | | |
| | MAX. No. of PSUs on 16A CIRCUIT BREAKER | 14 units (circuit breaker of type B) / 24 units (circuit breaker of type C) at 230VAC | | | | | | | | |
| LEAKAGE CURRENT | <0.75mA / 240VAC | | | | | | | | | |
| PROTECTION | OVER CURRENT | 95 ~ 108% Constant current limiting, recovers automatically after fault condition is removed | | | | | | | | |
| | SHORT CIRCUIT | Hiccup mode, recovers automatically after fault condition is removed | | | | | | | | |
| | OVER VOLTAGE | 15 ~ 18V | 17.5 ~ 21V | 23 ~ 27V | 28 ~ 35V | 34 ~ 40V | 41 ~ 49V | 46 ~ 54V | 54 ~ 63V | 59 ~ 66V |
| | OVER TEMPERATURE | Shut down o/p voltage, recovers automatically after temperature goes down | | | | | | | | |
| ENVIRONMENT | WORKING TEMP. | Tcase=-35 ~ +70°C (Please refer to "OUTPUT LOAD vs TEMPERATURE" section) | | | | | | | | |
| | MAX. CASE TEMP. | Tcase=+70°C | | | | | | | | |
| | WORKING HUMIDITY | 20 ~ 95% RH non-condensing | | | | | | | | |
| | STORAGE TEMP., HUMIDITY | -40 ~ +80°C, 10 ~ 95% RH | | | | | | | | |
| | TEMP. COEFFICIENT | ±0.03%/°C (0 ~ 50°C) | | | | | | | | |
| | VIBRATION | 10 ~ 500Hz, 2G 12min./1cycle, period for 72min. each along X, Y, Z axes | | | | | | | | |
| SAFETY & EMC | SAFETY STANDARDS <small>Note.8</small> | UL18750, CSA C22.2 No. 250.0-08; ENEC EN61347-1, EN61347-2-13 independent, EN62384, J61347-1, J61347-2-13 approved, IP67 (optional); Design refer to UL60950-1, TUV EN60950-1 | | | | | | | | |
| | WITHSTAND VOLTAGE | I/P-O/P:3.75KVAC | | | | | | | | |
| | ISOLATION RESISTANCE | I/P-O/P:100M Ohms / 500VDC / 25°C / 70% RH | | | | | | | | |
| | EMC EMISSION <small>Note.8</small> | Compliance to EN55015, EN61000-3-2 Class C (@load ≥ 50%); EN61000-3-3 | | | | | | | | |
| EMC IMMUNITY | Compliance to EN61000-4-2, 3, 4, 5, 6, 8, 11; EN61547, light industry level (surge immunity Line-Line 2KV) | | | | | | | | | |
| OTHERS | MTBF | 473.3Khrs min. MIL-HDBK-217F (25°C) | | | | | | | | |
| | DIMENSION | 148*40*32mm (L*W*H) | | | | | | | | |
| | PACKING | 0.21Kg; 40pcs/9.4Kg/1.02CUFT | | | | | | | | |
| NOTE | <ol style="list-style-type: none"> All parameters NOT specially mentioned are measured at 230VAC input, rated current and 25°C of ambient temperature. Please refer to "DRIVING METHODS OF LED MODULE". Ripple & noise are measured at 20MHz of bandwidth by using a 12" twisted pair-wire terminated with a 0.1µf & 47µf parallel capacitor. Tolerance : includes set up tolerance, line regulation and load regulation. De-rating may be needed under low input voltages. Please refer to "STATIC CHARACTERISTIC" sections for details. Length of set up time is measured at first cold start. Turning ON/OFF the driver may lead to increase of the set up time. The driver is considered as a component that will be operated in combination with final equipment. Since EMC performance will be affected by the complete installation, the final equipment manufacturers must re-qualify EMC Directive on the complete installation again. The model certified for CCC(GB19510.14, GB19510.1, GB17743 and GB17625.1) is an optional model . Please contact MEAN WELL for details. This series meets the typical life expectancy of >50,000 hours of operation when Tcase, particularly (C) point (or TMP, per DLC), is about 70°C or less. Please refer to the warranty statement on MEAN WELL's website at http://www.meanwell.com | | | | | | | | | |

■ **BLOCK DIAGRAM**

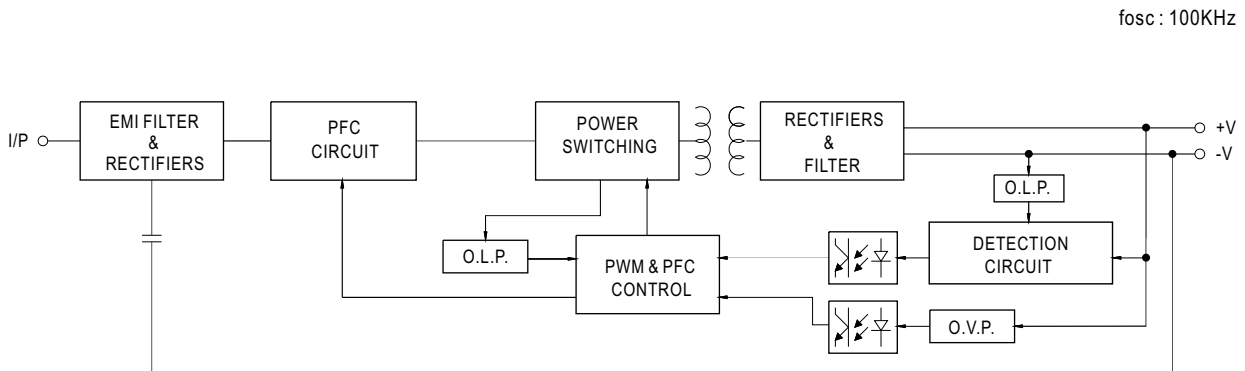

■ **DRIVING METHODS OF LED MODULE**

※ This series is able to work in either Constant Current mode (a direct drive way) or Constant Voltage mode (usually through additional DC/DC driver) to drive the LEDs.



Typical output current normalized by rated current (%)

In the constant current region, the highest voltage at the output of the driver depends on the configuration of the end systems.
Should there be any compatibility issues, please contact MEAN WELL.

OUTPUT LOAD vs TEMPERATURE

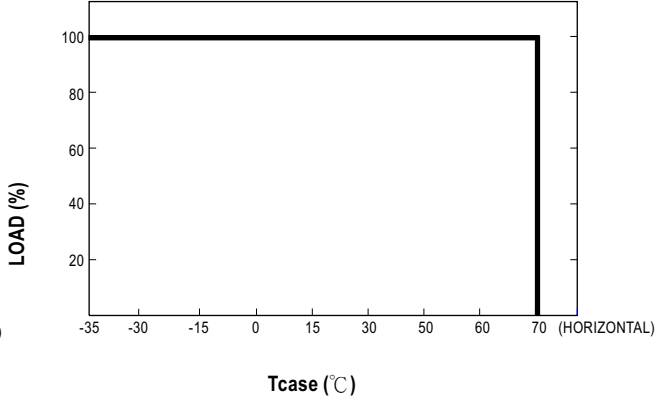
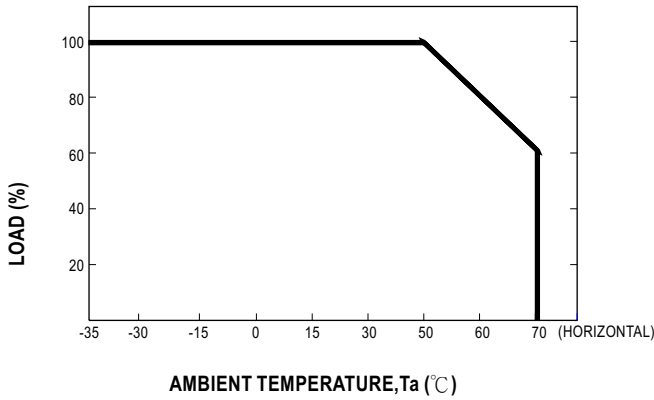

STATIC CHARACTERISTIC

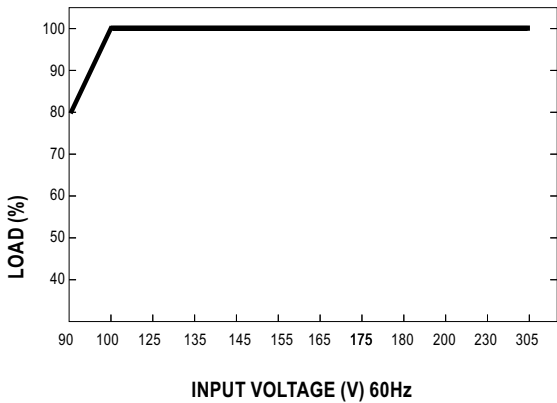

※ De-rating is needed under low input voltage.

POWER FACTOR (PF) CHARACTERISTIC

※ Tcase at 60°C

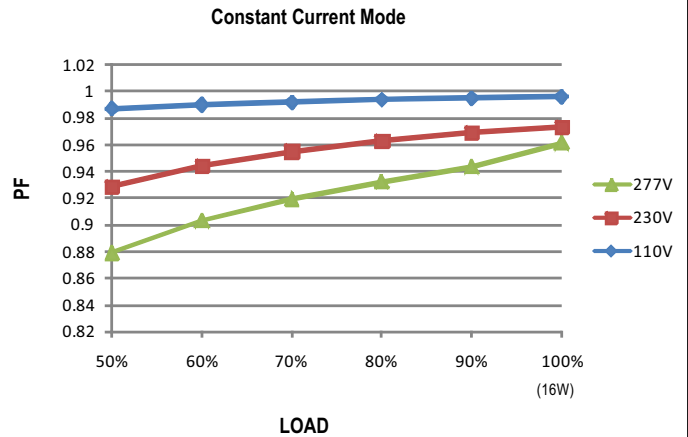

TOTAL HARMONIC DISTORTION (THD)

※ 48V Model, Tcase at 60°C

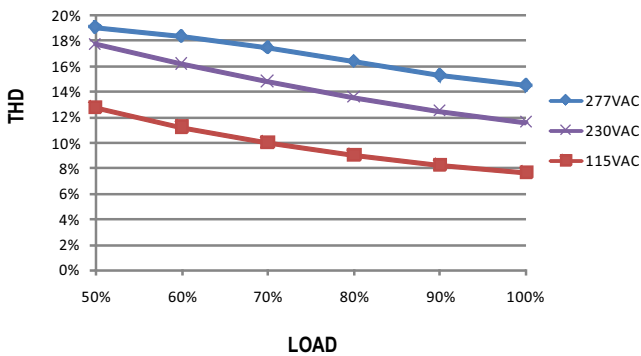

EFFICIENCY vs LOAD

LPF-16 series possess superior working efficiency that up to 86% can be reached in field applications.

※ 48V Model, Tcase at 60°C

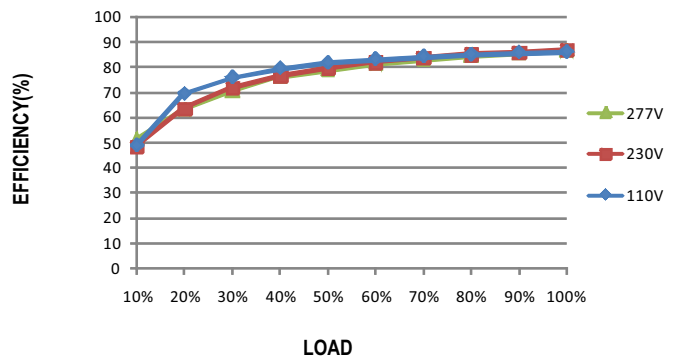



■ LIFE TIME

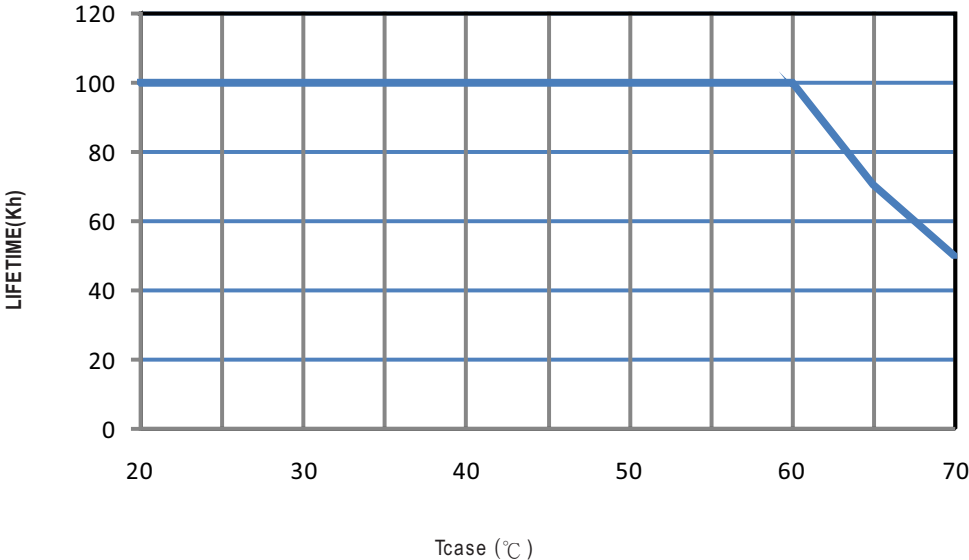

MECHANICAL SPECIFICATION

CASE NO.: LPF-16A Unit:mm

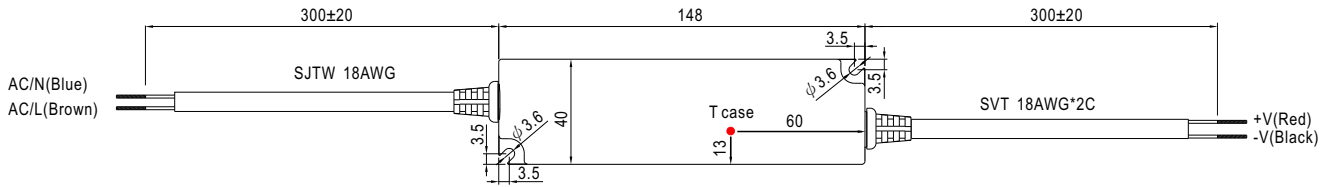

INSTALLATION MANUAL

Please refer to : <http://www.meanwell.com/webnet/search/InstallationSearch.html>