

# Peak Atlas DCA Pro

*Advanced Semiconductor Component Analyser  
with Graphics Display and PC connectivity  
Model DCA75*

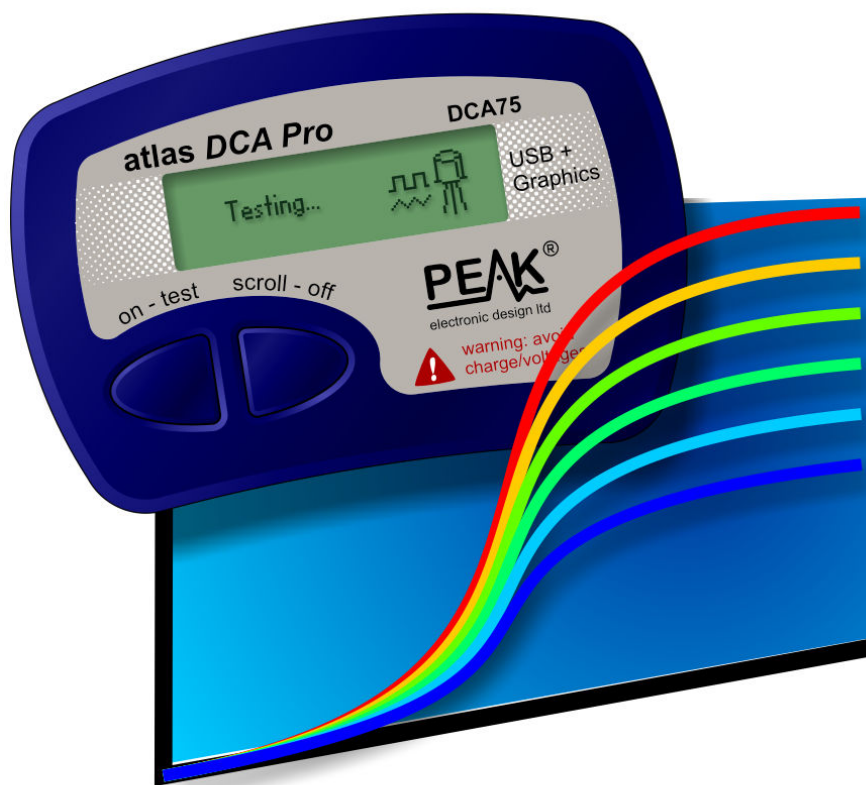

Designed and manufactured with pride in the UK

## User Guide

© Peak Electronic Design Limited 2012/2014

In the interests of development, information in this guide is subject to change without notice - E&OE



## **Want to use it now?**

We understand that you want to use your *Atlas DCA Pro* right now. The unit is ready to go and you should have little need to refer to this user guide, but please make sure that you do at least take a look at the notices on page 5.

<b>Contents</b>	<b>Page</b>
Introduction.....	4
Important Considerations .....	5
Analysing semiconductors - Standalone mode.....	6
Diodes.....	8
Zener Diodes.....	9
Diode Networks.....	10
LEDs.....	11
Bicolour LEDs (2-lead types) .....	12
Bicolour LEDs (3-lead types) .....	13
Bipolar Junction Transistors (BJTs).....	14
Darlington Transistors .....	18
Enhancement Mode MOSFETs .....	21
Depletion Mode MOSFETs .....	22
Enhancement Mode IGBTs.....	23
Depletion Mode IGBTs.....	24
Junction FETs (JFETs) .....	25
Thyristors (SCRs) and Triacs.....	27
Voltage Regulators .....	28

Contents continued on next page...

<b>Contents (continued)</b>	<b>Page</b>
<b>PC Software Installation</b> .....	29
Connecting to your PC for the first time .....	30
Analysing Semiconductors – PC mode .....	31
PC mode - Curve Tracing functions.....	32
PC mode - Exporting your data.....	33
PC mode - Special functions .....	34
Audible Settings.....	35
Care of your <i>Atlas DCA Pro</i> .....	36
Self Test Procedure .....	37
Appendix A - Troubleshooting .....	38
Appendix B - Technical Specifications.....	39
Appendix C - Analysis test circuits.....	41
Transistor test circuit .....	41
JFET/MOSFET/IGBT test circuit.....	42
Diode test circuit.....	43
Voltage regulator test circuit.....	44
Appendix D - Warranty Information.....	45
Appendix E - Disposal information .....	46

## Introduction

The *Peak Atlas DCA Pro* is an advanced semiconductor analyser that combines simplicity, ease of use and a range of advanced features. You can use your *DCA Pro* on its own or in combination with a laptop or desktop PC.

### Summary Features:

- Automatic component type identification and schematic display
  - Bipolar transistors
  - Darlington transistors
  - Enhancement Mode and Depletion Mode MOSFETs
  - Enhancement Mode and Depletion Mode IGBTs
  - Junction FETs
  - Low power sensitive Triacs and Thyristors
  - Light Emitting Diodes
  - Bicolour LEDs
  - Diodes and Diode networks
  - Zener diodes
  - Voltage regulators
- Automatic pinout identification, just connect any way round.
- Special feature identification such as free-wheeling diodes and resistor shunts.
- Gain measurement for bipolar transistors.
- Leakage current measurement for bipolar transistors.
- Silicon and Germanium detection for bipolar transistors.
- Gate threshold measurement for Enhancement Mode MOSFETs.
- Semiconductor forward voltage measurement for diodes, LEDs and transistor Base-Emitter junctions.
- Zener voltage measurement.
- PC connectivity providing:
  - Larger component identification display.
  - Detailed characteristics measurement.
  - Curve tracing functions.
- Automatic and manual power-off.

## Important Considerations

Please observe the following guidelines:

- This instrument must NEVER be connected to powered equipment/components or equipment/components with any stored energy (e.g. charged capacitors). Failure to comply with this warning may result in personal injury, damage to the equipment under test, damage to your *DCA Pro* and invalidation of the manufacturer's warranty.
- The *DCA Pro* is designed to analyse semiconductors that are not in-circuit, otherwise complex circuit effects will result in erroneous measurements.
- Avoid rough treatment, hard knocks and extreme temperatures.
- This unit is not waterproof.
- Only use a good quality AAA Alkaline battery.

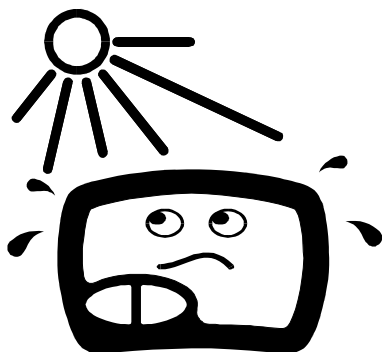

## Analysing Components – Standalone Mode

The *DCA Pro* is designed to analyse discrete, unconnected, unpowered components. This ensures that external connections don't influence the measured parameters. The three test probes can be connected to the component any way round. If the component has only two terminals, then any pair of the three test probes can be used.

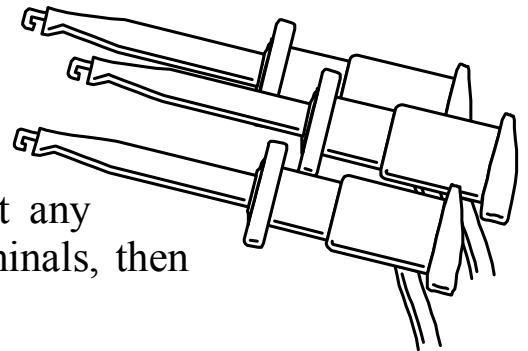

The *DCA Pro* will start component analysis when the **on-test** button is pressed.



For the first analysis (after the unit has been switched off) the tests are performed while displaying the Peak logo.

For subsequent testing when the unit is already powered-up, the unit displays the “Testing...” screen.

Depending on the component type, analysis may take a few seconds to complete, after which, the results of the analysis are displayed.

Information is displayed a “page” at a time, each page can be smoothly scrolled by briefly pressing the **scroll-off** button.



Although the *DCA Pro* will switch itself off if left unattended, you can manually switch the unit off by holding down the **scroll-off** button for a couple of seconds.

If the *DCA Pro* cannot detect any component between any of the test probes, the following message will be displayed:

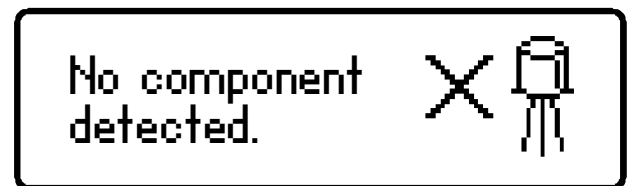

If the component is not a supported component type, a faulty component or a component that is being tested in-circuit, the analysis may result in the following message being displayed:

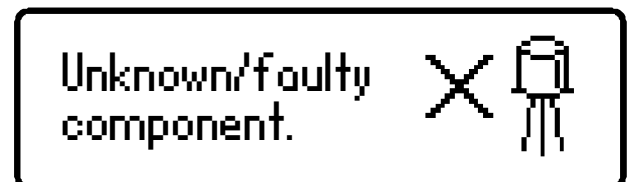

Some components may be faulty due to a shorted junction between a pair of the probes. If this is the case, the following message (or similar) will be displayed:



If all three probes are shorted (or very low resistance) then the following message will be displayed:



It is possible that the *DCA Pro* may detect one or more diode junctions or other component type within an unknown or faulty part. This is because many semiconductors comprise of PN (diode) junctions. Please refer to the section on diodes and diode networks for more information.

## Diodes

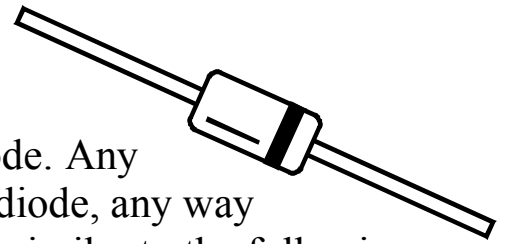

The *DCA Pro* will analyse almost any type of diode. Any pair of the three test clips can be connected to the diode, any way round. If the unit detects a single diode, a message similar to the following will be displayed:

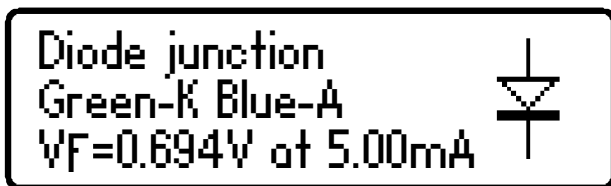

In this example, the Cathode (symbol of K) is connected to the Green test clip and the Anode (symbol of A) is connected to the Blue test clip,

additionally, the Red test clip is unconnected.

The forward voltage drop is also displayed; this gives an indication of the diode technology. In this example, it is likely that the diode is a standard silicon diode. A germanium or Schottky diode may yield a forward voltage of about 0.25V. The current at which the diode was tested is also displayed. The *DCA Pro* typically tests diodes (PN junctions) at a forward current of 5mA.



Note that the *DCA Pro* will detect only one diode even if two diodes are connected in series when the third test clip is not connected to the junction between the diodes. The forward voltage drop displayed however will be the voltage across the whole series combination.



The *DCA Pro* will determine that the diode(s) under test is an LED if the measured forward voltage drop exceeds 1.50V. Please refer to the section on LED analysis for more information.



## Zener Diodes

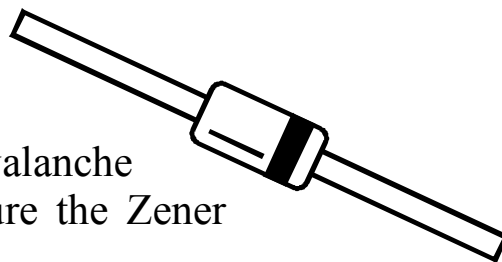

The *DCA Pro* supports Zener diodes (and Avalanche diodes). Additionally, the instrument can measure the Zener voltage\*.

Connect any pair of the 3 test leads to the Zener diode.

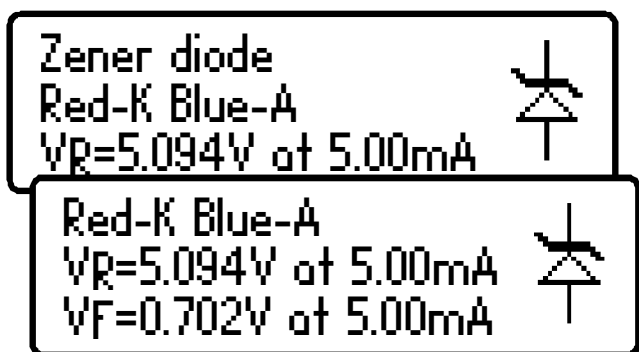

Following analysis, the component details are displayed.

In this example, a Zener diode with a reverse voltage (Zener voltage) of nearly 5.1V has been detected. Additionally, the forward biased voltage characteristic is measured, 0.702V at 5mA for this example.

The *DCA Pro* attempts to test the Zener diode with a current of nominally 5mA. For Zener diodes with a Zener voltage of more than about 9V, a lower test current will be used. This is illustrated in the following graph:

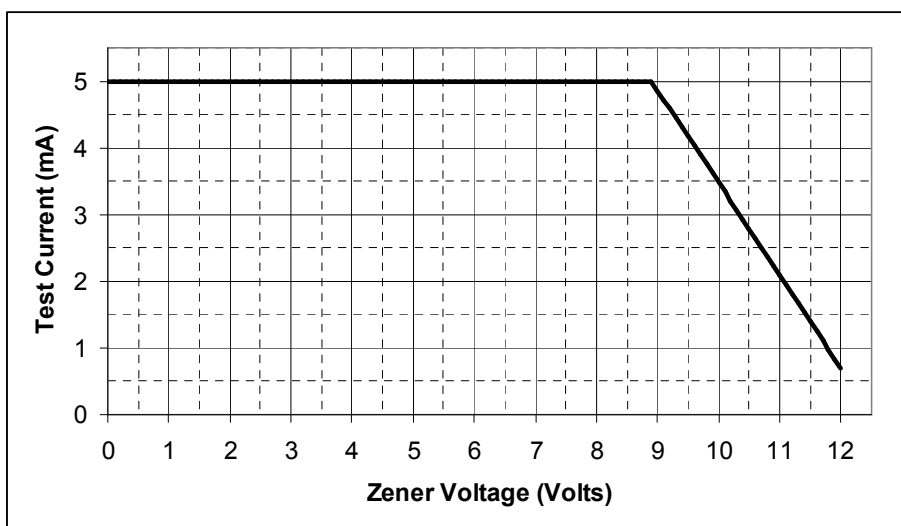

\*The *DCA Pro* may not be able to identify Zener diodes with a Zener voltage of more than 11V. It will however still identify the diode junction in its forward biased mode.

## Diode Networks

The *DCA Pro* will identify multiple diode junctions between the probes. For three terminal devices such as SOT-23 diode networks, all three test clips must be connected.

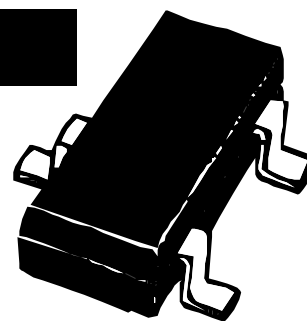

The instrument will show the results for each diode junction in turn.

Firstly, the unit will show that it has found a number of diode junctions:

2 diode junctions  
#1: Diode junction  
Green-K Blue-A



The details for the first diode are then displayed (Diode #1). In this example, the Green test clip is on the Cathode of diode #1 and the Blue test clip is on the Anode.

#1: Diode junction  
Green-K Blue-A  
VF=0.699V at 5.00mA



The details for the second diode are then displayed (by briefly pressing **scroll-off**):

#2: Diode junction  
Red-A Blue-K  
VF=0.683V at 5.00mA



It can be seen in the above example, that the blue test clip is connected to both the anode on Diode #1 and to the cathode of Diode #2. This means that the two diodes are effectively connected in series, with the blue clip at the mid point. This example is illustrated below:

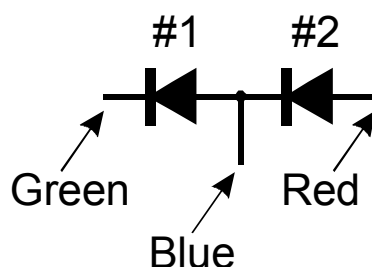

In the same way as the single diode analysis, the forward voltage for each diode is measured for a nominal test current of 5mA.

## LEDs

An LED (light emitting diode) is really just another type of diode, however, the *DCA Pro* will determine that an LED or LED network has been detected if the diode's measured forward voltage drop is larger than 1.5V. This also enables the *DCA Pro* to intelligently identify bicolour LEDs, both two-lead and three-lead varieties. See the section on bicolour LEDs for more information.

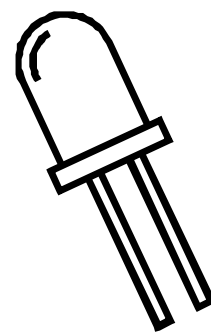

For two leaded parts, connect any pair of the 3 test clips to your LED. Leave the 3<sup>rd</sup> lead unconnected.

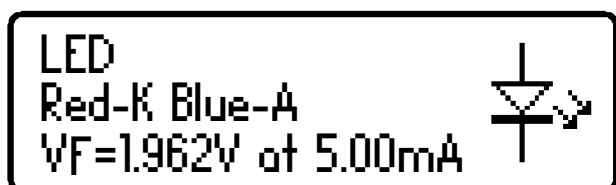

In this example, the Red test clip is connected to the LED's Cathode (negative) and the Blue test clip is connected to the Anode (positive).

The forward voltage of the LED is measured at a nominal current of 5mA.



During the analysis process, the LED will briefly illuminate (so you can see its illumination colour). The test current of 5mA means that it may not be as bright as you expect, LEDs are often used at currents of 10-20mA. Power LEDs are sometimes driven at 350mA or more.

# Bicolour LEDs (2-lead types)

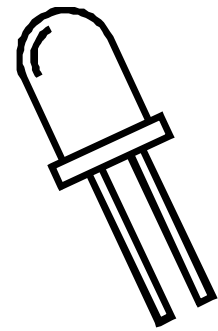

Bicolour LEDs are generally available in two main varieties; 2-lead and 3-lead types.

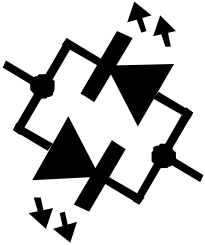

This section describes the testing of 2-lead bicolour LEDs. These types are internally connected in inverse parallel (back-to-back).

Similar to the diode network analysis, each LED within the bicolour LED is detailed in turn.

This example shows that LED #1 has its Cathode connected to the Red test clip and its Anode connected to the Blue test clip. The forward bias characteristic is shown for LED#1, 1.823V at 5mA in this example.

Bicolour LED (2 lead) #1: LED Red-K Blue-A	
#1: LED Red-K Blue-A VF=1.823V at 5.00mA	
#2: LED Red-A Blue-K VF=1.944V at 5.00mA	

Pressing **scroll-off** then shows the details for the 2<sup>nd</sup> LED in the bicolour LED package.

As expected for 2-lead bicolour LEDs, we can see in this example that LED#2 has its connections in exactly the opposite configuration to LED#1.



Note that it is common for the two LEDs within a bicolour LED to have different forward voltage characteristics. Red is often the lowest forward voltage, progressing through amber, yellow, green and then blue (or white) with the highest forward voltage. **See the table at the bottom of the next page.**

## Bicolour LEDs (3-lead types)

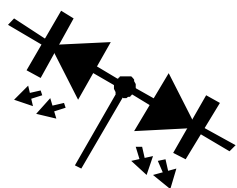
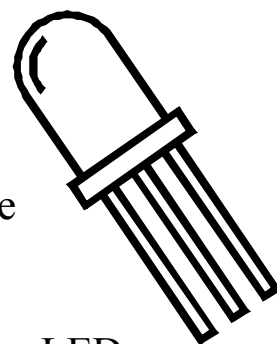

3-lead bicolour LEDs are available in common cathode and common anode varieties. The *DCA Pro* supports both types.

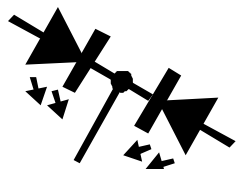

In the same way as the 2-lead bicolour LED analysis, each internal LED is detailed separately on the *DCA Pro* screen.

The type of bicolour LED is shown here, in this example we have a common cathode variety.

The details for each internal LED are then shown.

It can be seen here that our example has its common cathode terminal connected to the Green test clip.

Bicolour LED (3 lead)  
 Common Cathode  
 #1: LED

#1: LED  
 Red-A Green-K  
 $V_F=1.935V$  at 5.00mA

#2: LED  
 Green-K Blue-A  
 $V_F=1.877V$  at 5.00mA



Typical values of forward voltage for LED colours are shown here:  
 (LED types/manufacturers may vary significantly)

LED Colour	Typical $V_F$ @ 5mA
Red	1.81V
Amber	1.86V
Yellow	1.90V
Green (standard type)	1.95V
Green (deep green / emerald)	2.84V
Blue (and white)	2.95V

## Bipolar Junction Transistors (BJTs)

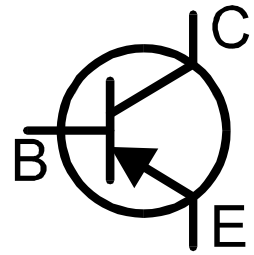

Bipolar Junction Transistors are simply “conventional” transistors, although variants of these do exist such as Darlingtons, devices with free-wheeling diodes, resistor shunted types and combinations of these types. All of these variations are automatically identified by the *DCA Pro* and their schematic symbol is displayed on the screen. Both NPN and PNP types are supported.

The 3 test clips can be applied to the transistor in any configuration.

As an example, testing a common PNP transistor such as the 2N5401 will result in a display similar to this:

This example shows that the Red test clip is connected to the Emitter, the Green is connected to the Base and the Blue test clip is connected to the Collector.

Pressing **scroll-off** allows further details to be displayed.

The DC current gain ( $H_{FE}$ ), base emitter voltage drop ( $V_{BE}$ ) and collector leakage current ( $I_{CLeak}$ ) are all shown along with their test conditions.

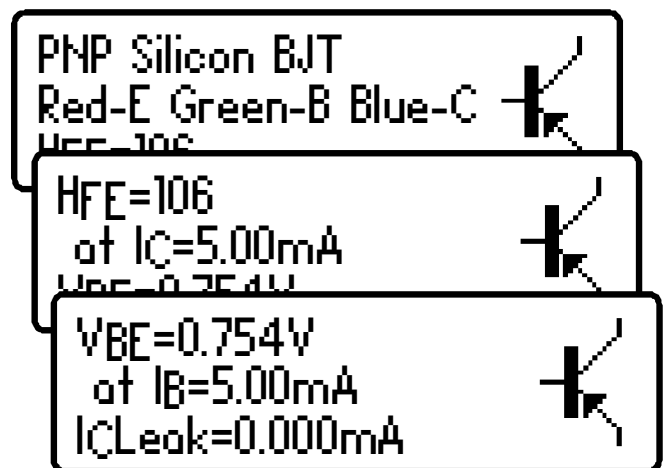

Refer to the following sections for more details on these measurements.

## Current Gain ( $H_{FE}$ )

DC current gain ( $H_{FE}$ ) is the ratio of the collector current (less leakage) to the base current for a particular operating condition.

The *DCA Pro* measures  $H_{FE}$  at a collector current of nominally 5.0mA and a collector-emitter voltage of between 3V and 9V.

The gain of all transistors can vary considerably with collector current, collector voltage and also temperature. The displayed value for gain therefore may not represent the gain experienced at other collector currents and voltages. This is particularly true for large devices.

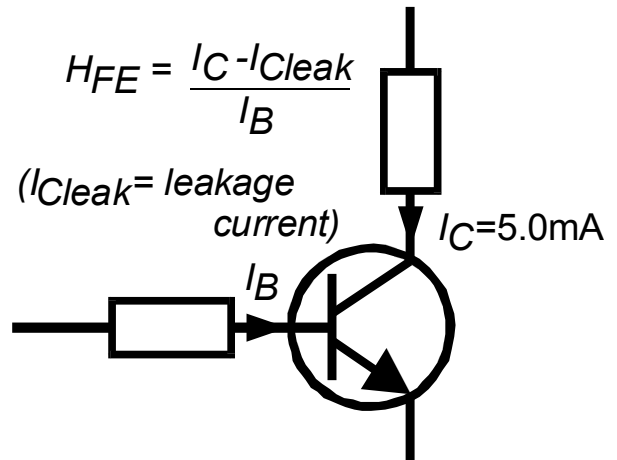

$H_{FE}=167$   
at  $I_C=5.00mA$



The displayed value of gain is very useful however for comparing transistors of a similar type for the purposes of gain matching or fault finding.

Darlington transistors can have very high gain values and more variation of gain will be evident as a result of this.



The current gain of germanium transistors can vary a large amount with changes in temperature. Even the warmth from your fingers can alter the gain of a germanium device.



It is quite normal for transistors of the same type to have a wide range of gain values. For this reason, transistor circuits are often designed so that their operation has little dependence on the absolute value of current gain.

## Base-Emitter Voltage Drop

The DC characteristics of the base-emitter junction are displayed, both the base-emitter forward voltage drop ( $V_{BE}$ ) and the base current ( $I_B$ ) used for the measurement.

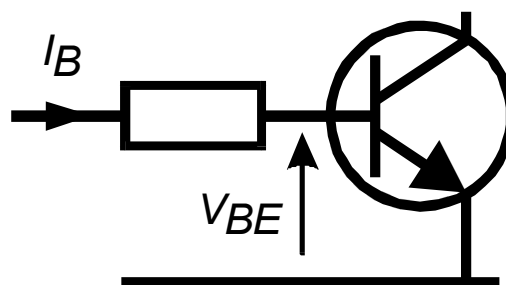

$V_{BE}=0.703V$   
at  $I_B=5.00mA$



This example shows an NPN base-emitter voltage ( $V_{BE}$ ) of 0.703V for a base test current ( $I_B$ ) of 5mA.

The forward base-emitter voltage drop can aid in the identification of silicon or germanium devices. Germanium devices can have base-emitter voltages as low as 0.2V, Silicon types exhibit readings of about 0.7V and Darlington transistors can exhibit readings of about 1.2V because of the multiple base-emitter junctions being measured.



It is important to note that the *DCA Pro* does not perform the base-emitter voltage drop tests at the same base current as that used for the current gain measurement.  $V_{BE}$  is measured at a base current of approximately 5mA. The base current used during the gain measurement is equal to  $I_C/H_{FE}$ .



## Collector Leakage Current

The collector current that takes place when no base current is flowing is referred to as *Leakage Current*.

Most modern transistors exhibit extremely low values of leakage current, often less than  $1\mu\text{A}$ , even for very high collector-emitter voltages.

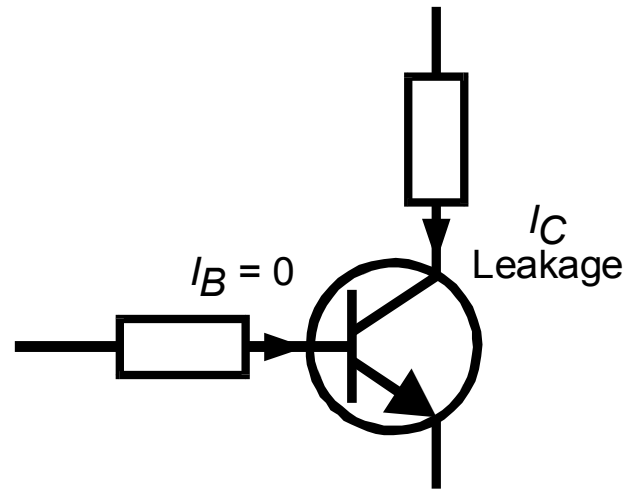

$V_{BE}=0.270\text{V}$   
at  $I_B=5.00\text{mA}$   
 $I_{CLeak}=0.177\text{mA}$



Older Germanium types however can suffer from significant collector leakage current, particular at high temperatures (leakage current can be very temperature dependant).

Leakage current is automatically taken into account for the gain measurement (unlike many multimeter's gain measurement that can be fooled by leakage current).



If your transistor is a Silicon type, you should expect to see a leakage current of close to  $0.000\text{mA}$  unless the transistor is faulty.



The leakage current of germanium transistors can vary a large amount with changes in temperature (roughly doubling with every  $5^\circ\text{C}$  increase). Even the warmth from your fingers can alter the leakage current of a germanium device. Conversely, a cooling transistor (after a little handling) can result in a falling leakage current measurement over the period of a few seconds/minutes. This is completely normal.

## Darlington Transistors

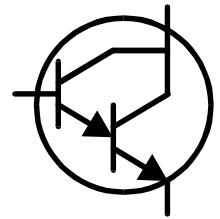

If the device is a Darlington transistor (two BJTs connected together), the unit will display a similar message to this:

NPN Darlington  
Red-B Green-E Blue-C  
HFE=9410



For Darlington devices that do not have internal resistors, the gain ( $H_{FE}$ ) can be very high as expected.

NPN Darlington  
Red-C Green-E Blue-B  
HFE=67



This second example however, (left) shows the display for a Darlington transistor that has internal resistors connected to the base-emitter connections. This causes the  $H_{FE}$

measurement to become much lower at the test currents used by the *DCA Pro*. This is normal and is not a fault with the transistor or the *DCA Pro*.



It is important to note that if a Darlington does contain a base-emitter shunt resistor network, any measurements of current gain ( $H_{FE}$ ) will be very low at the test currents used by the *DCA Pro*. This is due to the resistors providing an additional path for the base current. The readings for gain however can still be used for comparing transistors of a similar type for the purposes of matching or gain band selecting.



Note that the *DCA Pro* will determine that the transistor under test is a Darlington type if the base-emitter voltage drop is greater than 1.00V for devices with a base-emitter shunt resistance of greater than 60k $\Omega$  or if the base-emitter voltage drop is greater than 0.80V for devices with a base-emitter shunt resistance of less than 60k $\Omega$ . The measured base-emitter voltage drop is displayed as detailed later in this section.

## Free Wheeling Diode

Some transistors, particularly CRT deflection transistors and many large Darlington transistors have a protection diode (“free wheeling diode” or “body diode”) inside their package connected between the collector and emitter.

If a free-wheeling diode has been detected, it is shown on the schematic symbol. Some examples are shown here:



The Philips BU505DF is a typical example of a diode protected bipolar transistor. Remember that the diode (if present) is always internally connected between the collector and the emitter so that it is normally reverse biased.

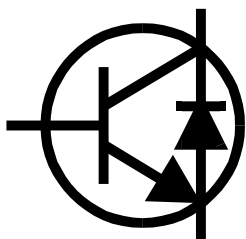

For NPN transistors, the anode of the diode is connected to the emitter of the transistor. For PNP transistors, the anode of the diode is connected to the collector of the transistor.

## Faulty or Very Low Gain Transistors

Faulty transistors that exhibit very low gain may cause the *DCA Pro* to only identify one or more diode junctions within the device. This is because NPN transistors consist of a structure of junctions that behave like a common anode diode network. PNP transistors can appear to be common cathode diode networks. The common junction represents the base terminal. This is normal for situations where the current gain is so low that it is immeasurable at the test currents used by the *DCA Pro*.

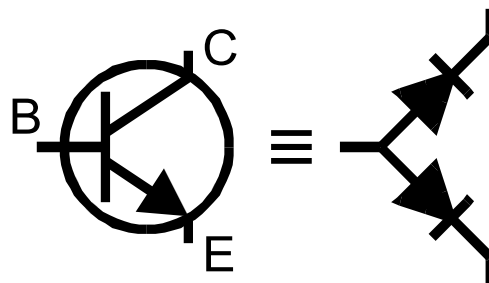

Please note that the equivalent diode pattern may not be correctly identified by the *DCA Pro* if your transistor is a darlington type or has additional diode(s) in its package (such as a collector-emitter protection diode). This is due to multiple pn junctions and current paths that cannot be uniquely resolved.

In some circumstances, the unit may not be able to deduce anything sensible from the device at all, in which case you may see one of these messages:

Unknown/faulty  
component.



No component  
detected.



## Enhancement Mode MOSFETs

MOSFET stands for *Metal Oxide Semiconductor Field Effect Transistor*. Like bipolar transistors, MOSFETs are available in two main types, N-Channel and P-Channel. Most modern MOSFETs are of the Enhancement Mode type, meaning that the bias of the gate-source voltage is always positive (For N-Channel types). The other (rarer) type of MOSFET is the Depletion Mode type which is described in a later section.

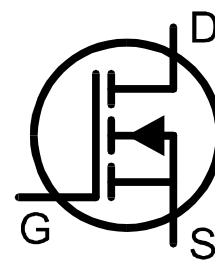

MOSFETs of all types are sometimes known as IGFETs, meaning *Insulated Gate Field Effect Transistor*. This term describes a key feature of these devices, an insulated gate region that results in negligible gate current for both positive and negative gate-source voltages (up to the maximum allowed values of course, typically  $\pm 20\text{V}$ ). IGFETs are not to be confused with IGBTs (Insulated Gate Bipolar Transistors), these are dealt with in a later section.

The first screen to be displayed gives information on the type of MOSFET detected and the pinout.

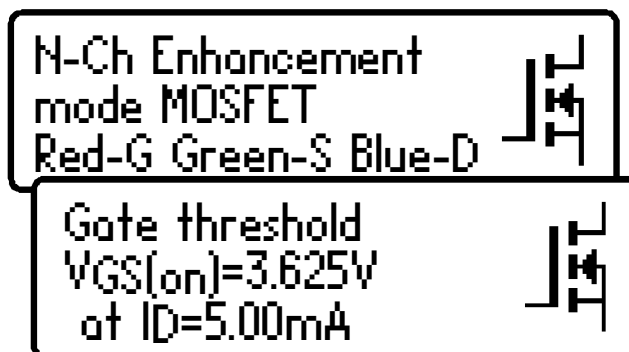

Pressing **scroll-off** will then result in the gate threshold of the MOSFET being displayed.

The (on) gate threshold voltage is the gate-source voltage at which conduction between the source and drain starts. The *DCA Pro* determines that drain-source conduction has started when it reaches a current of 5.00mA, this is confirmed on the display.

An enhancement MOSFET will always have a gate threshold voltage of greater than 0V (ie. always positive relative to the source pin for N channel devices).

The *DCA Pro* can drive the gate from 0V to 10V for enhancement mode MOSFETs.

# Depletion Mode MOSFETs

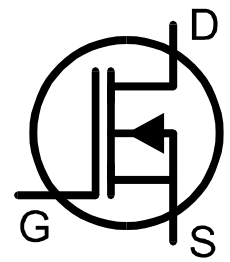

The fairly rare Depletion Mode MOSFET is very similar to the conventional Junction FET (JFET) except that the gate terminal is insulated from the other two terminals. The input resistance of these devices can typically be greater than 1000MΩ for negative and positive gate-source voltages.

Depletion Mode devices are characterised by the gate-source voltage required to control the drain-source current.

N-Ch Depletion mode MOSFET  
 Red-S Green-G Blue-D



Gate threshold  
 $V_{GS(on)} = -2.918V$   
 at  $I_D = 5.00mA$



Modern Depletion Mode devices are generally only available in N-Channel varieties and will conduct some current between its drain and source terminals even with a zero voltage applied across the gate and the source. The device can only be turned completely off by taking its gate significantly more negative than its source terminal, say  $-5V$ . It is this characteristic that makes them so similar to conventional JFETs.

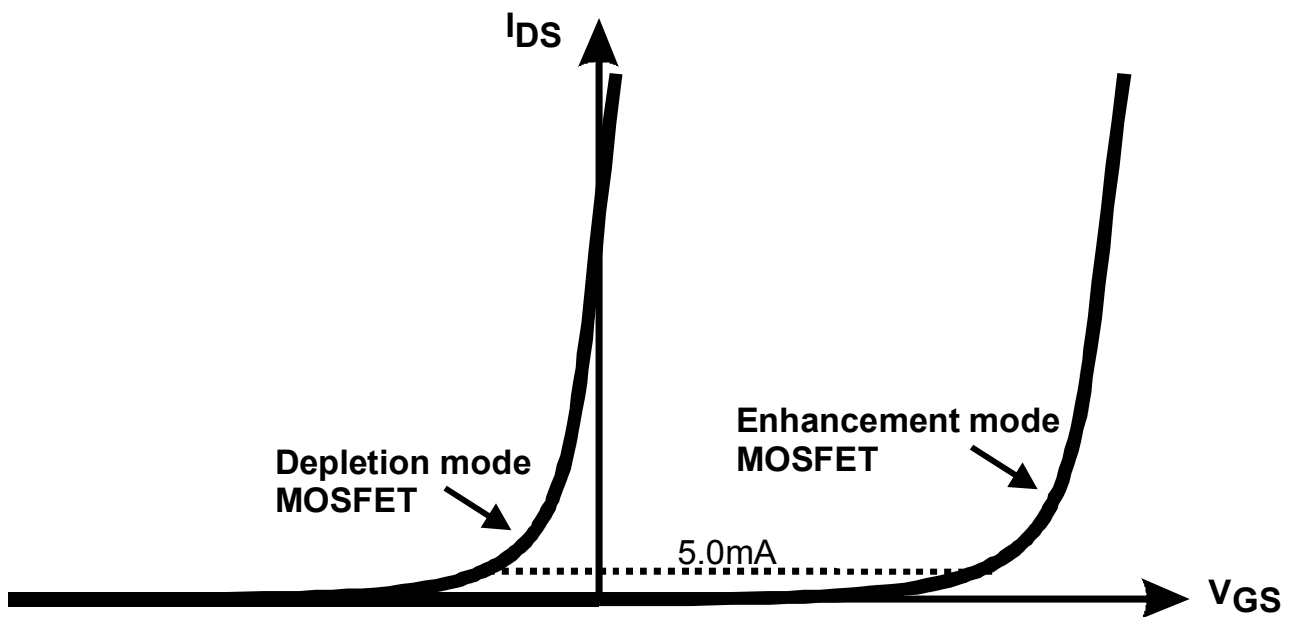

## Enhancement Mode IGBTs

IGBT is an acronym for Insulated Gate Bipolar Transistor.

It combines the input characteristics of a MOSFET with the output characteristics of a Bipolar Junction Transistor.

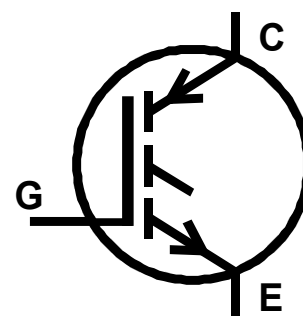

IGBTs are available in N or P channel types, enhancement mode or depletion mode and with or without a free-wheeling diode.

Generally, their operation is very similar to MOSFETs. The saturation capability of an IGBT is often better than an equivalent sized MOSFET at high currents. At low currents, the saturation voltage of an IGBT is often worse than an equivalent sized MOSFET.

In this example we have an N-Channel IGBT with an integral free wheeling diode.

Note the names of the leads; Gate, Collector and Emitter.

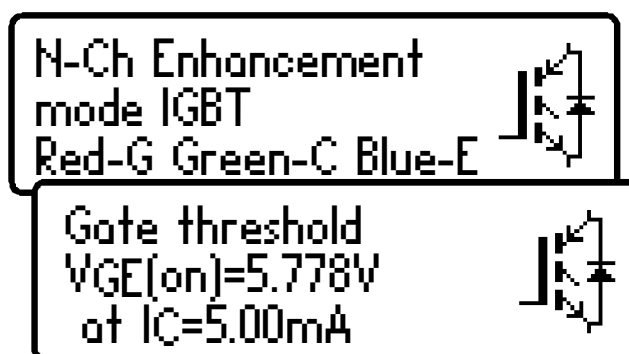

Similar to the MOSFET analysis, the gate threshold is the voltage between the gate and emitter that causes the device to start conducting (between the collector and emitter). The *DCA Pro* determines that conduction has started if the collector current has reached 5.0mA.

The *DCA Pro* can drive the gate from 0V to 10V for enhancement mode IGBTs.

(IGBT symbol based on EN60617: 05-05-19)

## Depletion Mode IGBTs

Like MOSFETs, IGBTs are available as enhancement mode and depletion mode types.

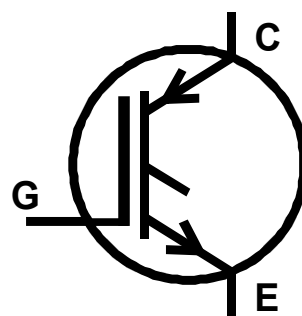

Depletion mode IGBTs are characterised by the fact that current can flow between the collector and emitter when there is zero voltage across the gate-emitter terminals.

For an N-Channel depletion mode IGBT, the device can only be turned off fully if the gate terminal is taken more negative with respect to the emitter lead.

In this example we have an N-Channel depletion mode IGBT with no free wheeling diode.

Note the negative gate threshold voltage, characteristic of a depletion mode device.

N-Ch Depletion mode IGBT Red-E Green-G Blue-E	
Gate threshold $V_{GE(on)} = -3.955V$ at $I_C = 5.00mA$	



## Junction FETs (JFETs)

Junction FETs are conventional Field Effect Transistors.

The voltage applied across the gate-source terminals controls current between the drain and source terminals. N-Channel JFETs require a negative voltage on their gate with respect to their source, the more negative the voltage, the less current can flow between the drain and source.

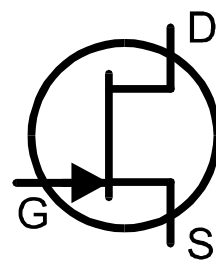

Unlike Depletion Mode MOSFETs, JFETs have no insulation layer on the gate. This means that although the input resistance between the gate and source is normally very high (greater than 100M $\Omega$ ), the gate current can rise if the semiconductor junction between the gate and source or between the gate and drain become forward biased. This can happen if the gate voltage becomes about 0.6V higher than either the drain or source terminals for N-Channel devices or 0.6V lower than the drain or source for P-Channel devices.

The internal structure of JFETs is essentially symmetrical about the gate terminal, this means that the drain and source terminals are often indistinguishable by the *DCA Pro*. The JFET type, gate terminal and measured parameters are displayed however.

N-Ch Junction FET  
Green-G  
Symmetrical Src/Drn



### Pinch-Off

A common parameter to be specified for JFETs is “Pinch-Off”. This is the voltage needed between the gate-source to turn off the JFET. The *DCA Pro* will determine that the JFET is off when the drain current is less than 1 $\mu$ A.

$V_{GS(off)} = -6.65V$   
at  $I_D = 1\mu A$

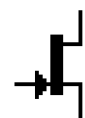

## “On” Characteristics

The *DCA Pro* measures the gate-source voltage required to reach the onset of good conduction through the JFET’s drain-source. Good conduction is determined when the drain-source current reaches 5mA. For JFETs that have a lower saturation current than 5mA, the *DCA Pro* will try to use a lower “on” current.

V<sub>GS(on)</sub> = -1.10V  
at I<sub>D</sub> = 5.00mA



## Transconductance

While the JFET is conducting, the JFET’s gain (transconductance) is measured.

Transconductance is often measured in mA/V (sometimes known as *mmhos* or *mSiemens*). This refers to the change in drain current that results from a change in gate-source voltage:

$$g_{fs} = \Delta I_{DS} / \Delta V_{GS}$$

The *DCA Pro* measures transconductance by determining the gate voltage change necessary to obtain a drain current change from 3.0mA to 5.0mA.

g<sub>fs</sub> = 13.6mA/V  
at I<sub>D</sub> = 3mA to 5mA

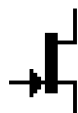

## Zero Gate-Source Voltage

Finally, the drain current for a zero gate-source voltage is measured.

I<sub>D</sub> = 6.67mA  
at V<sub>GS</sub> = 0.00V  
and V<sub>DS</sub> = 4.78V



Transconductance is measured by the *DCA Pro* over a small range of drain current (typically a span of 3mA-5mA). Values of transconductance higher than 20mA/V can yield a coarse measurement resolution because the required change in gate voltage is so tiny. Additionally, values above 99mA/V are displayed as “>99mA/V”.

## Thyristors (SCRs) and Triacs

Sensitive low power thyristors (Silicon Controlled Rectifiers - SCRs) and triacs that require gate currents and holding currents of less than 10mA can be identified and analysed with the *DCA Pro*.

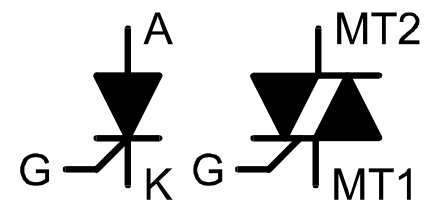

Thyristor terminals are the anode (A), cathode (K) and the gate (G).

This example shows that a thyristor has been detected:

Thyristor (SCR)  
Red-G Green-K Blue-A 

Triac terminals are MT1, MT2 (MT standing for main terminal) and gate. MT1 is the terminal with which gate current is referenced.

Triac  
Red-MT1 Green-G  
Blue-MT2 



1. The unit determines that the device under test is a triac by checking the gate trigger quadrants that the device will reliably operate in. Thyristors operate in only one quadrant (positive gate current, positive anode current). Triacs can typically operate in three or four quadrants, hence their use in AC control applications.

2. The gate trigger currents used by the *DCA Pro* are limited to less than 10mA. Some thyristors and triacs will not operate at low currents and these types cannot be analysed with this instrument. Note also that if only one trigger quadrant of a triac is detected then the unit will conclude that it has found a thyristor. Please see the technical specifications for more details. The *Atlas SCR* (model SCR100) instrument is designed for analysing triacs and thyristors that require currents up to 100mA to operate.

## Voltage Regulators

Voltage regulators are available in many different types and different packages.

The *DCA Pro* is able to identify many types of regulator, typically regulators with outputs less than 8V, depending on current requirements.

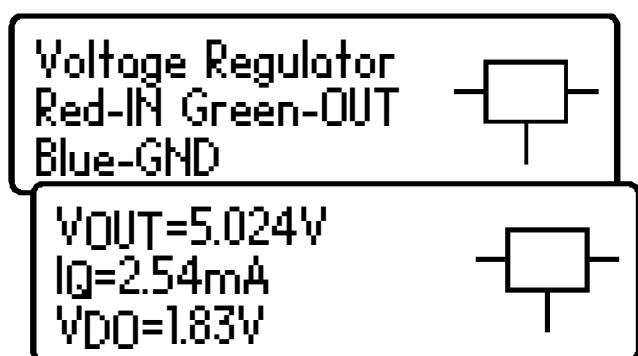
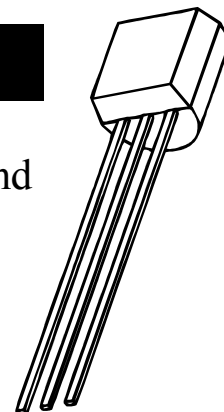

When a regulator is identified, its pinout, output voltage, quiescent current consumption and drop-out voltage are displayed.

Negative voltage regulators (such as the popular 79L05) will be shown with a negative  $V_{OUT}$  figure.



The displayed drop-out voltage ( $V_{DO}$ ) is the voltage that is required between input and output of the regulator to enable voltage regulation to take place. Common regulators have a drop-out voltage of around 2V. Many “*Low drop-out*” regulators may have a drop-out voltage of 0.5V or less. The *DCA Pro* measures drop-out at very low load currents on the regulator’s output (typically less than 1mA). The drop-out voltage of a regulator increases significantly with load current.



Some voltage regulators are not stable when used outside of their intended circuitry (decoupling capacitors, proper loads etc). The *DCA Pro* may not be able to identify the regulator correctly if it is not stable during analysis.

## PC Software Installation

The *DCA Pro* can be used in conjunction with a PC running Windows XP or later.\*

Software is provided on the included USB flash drive. Alternatively, you can download the latest PC software package from:

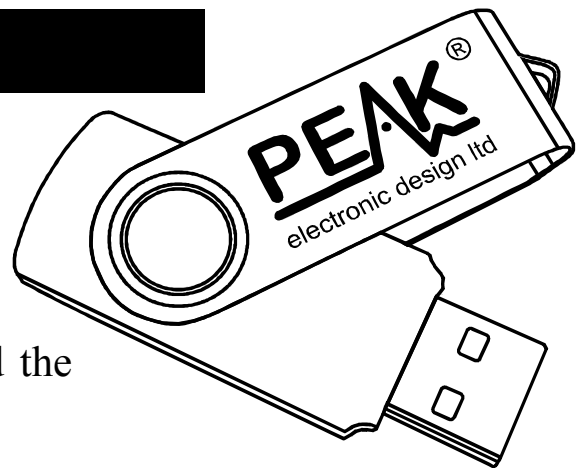

[www.peakelec.co.uk/downloads/dcaprosetup.exe](http://www.peakelec.co.uk/downloads/dcaprosetup.exe)

Before you install the software, ensure you have sufficient (administrator) rights on your machine. Additionally, ensure your PC meets the following requirements:

Windows XP, Vista, 7 or later.\*

1GB RAM.

1GB Hard Disk free.

Display size 1024 x 600 minimum (typical netbook resolution).

16 bit colour or better.

USB 1.1 or better.

.NET framework 4 (automatically installed if required).

Internet connection required for online updates.

\* Verified on UK localisation of Windows 8 at time of this user guide going to print.

Run the file “setup.exe” to install the *DCA Pro* companion software. Follow the instructions that are then displayed.

If required, the installation process will offer to install the .NET framework 4 on your computer. This is necessary for the program to work. It may take several minutes to install.

When your software is installed, you are ready to connect...

## Connecting to your PC for the first time

After the software has successfully installed, it is time to connect the *DCA Pro* to your PC.

Use the supplied USB cable to connect your instrument to a convenient USB socket on your PC. For best performance, we recommend that you connect directly to a USB socket on your PC rather than via a USB hub. If you do use a hub, please make sure it is a powered hub (500mA at 5V).

After connecting your *DCA Pro* for the first time, your PC may request the installation of the USB drivers (if it doesn't perform that automatically).

If requested to do so, complete the “Add new hardware” wizard and follow the recommended steps shown on your screen.

Wait for the message “Your new device is ready to use” before proceeding.

Now you're ready to start the *DCA Pro* companion software. You can double click on the desktop icon, click on the “DCA Pro” item in the “Peak” folder of your start menu or you can type “DCA Pro” into your Windows 7 search box.

When the program has started, you should see the message **DCA Pro connected** in the bottom left corner of the program window.

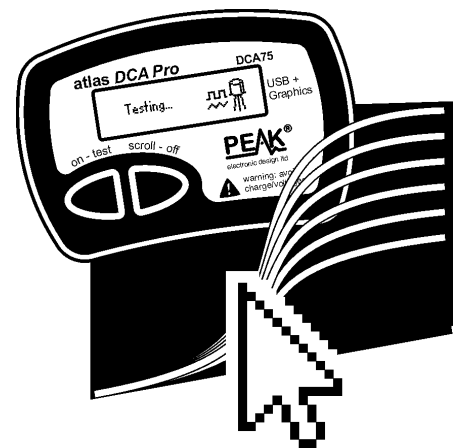

For the first time you use the software, if you see the message: **DCA Pro disconnected** then try unplugging the USB cable, wait a few seconds and plug back in. If that doesn't work (depending on your version of Windows) then you may need to restart your PC to allow the WinUSB drivers to initialise.

# Analysing Semiconductors – PC Mode

When the *DCA Pro* is connected to the PC and the PC is running the companion software, the instrument can be used from the PC screen or from the instrument itself.

Pressing “Test” will initiate a component analysis in just the same way as the standalone mode.

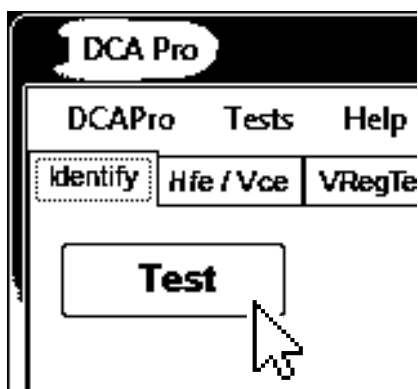

or

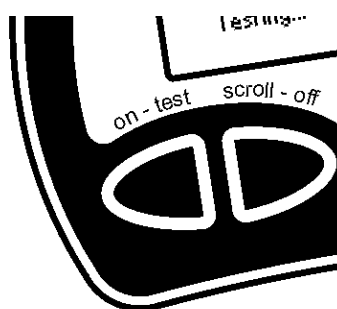

Any test results are automatically passed to the PC software and displayed in a text window. Additionally, the component schematic and the colour-coded pinout are also displayed:

**PNP Darlington BJT**  
 Red-E Green-B Blue-C  
 HFE=15950 at  $I_c=4.99\text{mA}$   
 $V_{be}=1.414\text{V}$  at  $I_b=3.01\text{mA}$   
 $I_{cLeak}=0.000\text{mA}$

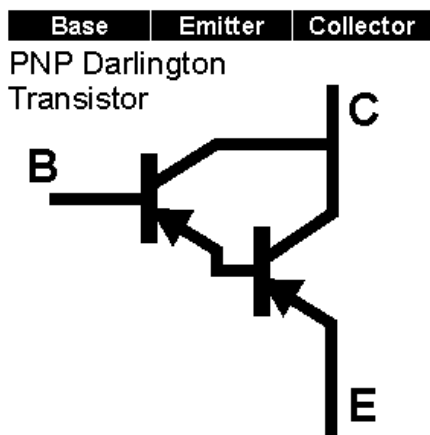

Note that the component schematic is displayed in colour to illustrate which colour test lead is connected to each component lead.

## Curve Tracing

After a component has been analysed, you can perform further tests on the component, such as curve tracing various component parameters.

Curve tracing is best performed after the *DCA Pro* has correctly identified the component and correctly identified the pinout.

Depending on the component type, various curve options will become available from the “Graphs” menu.

Selecting the desired curve type will take you to a fresh curve tab.

In many cases, you can simply start a new curve with the automatically selected parameters by clicking the curve “start” button.

A rectangular button with a black border and the word "Start" in bold black text.

You may adjust the parameters, but any parameters that are out of range may lead to unexpected results. Refer to *Appendix C* in this user guide that shows the analysis test circuits to see how test parameters are applied.

You may not be able to perform curve tracing in the following circumstances:

- Transistor gain is very low and the *DCA Pro* is unable to generate sufficient base current to obtain a sufficient span of collector current.
- Transistor (Darlington) gain is extremely high which means that the tiny base currents cannot be generated with fine enough resolution.
- If the component requires more than 12mA (into a short circuit) to analyse.
- If the component requires more than 12V (into an open circuit) to analyse.
- If the component requires a combination of voltage and current that cannot be generated (due to 700 Ohm current limiting resistance).



## Curve Tracing – Export Raw Data

After the curve tracing operation has completed, you can copy the raw measurement data into the clipboard ready to be pasted into your spreadsheet program.

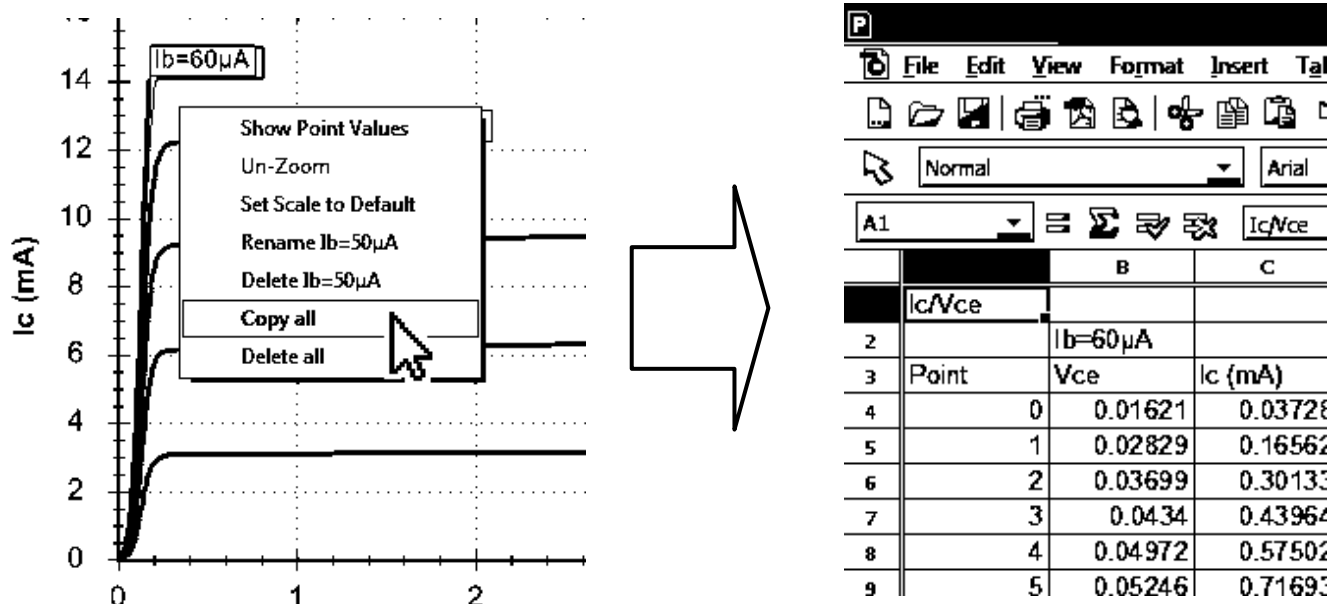

Pasting the data into a spreadsheet is an ideal way of documenting important test results.

Simply right-click on one of the curves and select “Copy all”. All the raw measurement data that created the curves is now in the clipboard. You can then paste the data into your spreadsheet.

This feature has been tested with *Microsoft Excel*<sup>™</sup>, *Softmaker Planmaker*<sup>©</sup> and *Apache Open Office*<sup>™</sup>. Other spreadsheet programs should work fine too.

Once the raw data is pasted into your spreadsheet, you can perform your own tasks such as charting and mathematical analysis.

## Special Functions

### Firmware Upgrade

From the program's "Help" menu, select "Check for Updates".

If you are connected to the internet, the program will check for new PC Software (that includes the latest firmware). If newer software is available, you will be guided to the download location.

The programming operation should take no more than a minute or so. Don't interrupt the process and wait for the confirmation that the programming operation has been successfully completed.



Don't worry if the firmware upgrade process doesn't succeed first time. Windows sometimes takes time to prepare the built-in HID driver that is used during the firmware upgrade process. If the firmware upgrade process fails, don't panic, just try again, it should be fine once Windows gets its built-in driver initialised.

### LCD Contrast

The PC software allows you to adjust the instrument's LCD contrast.

From the program's "DCA Pro" menu, select "LCD Contrast".

You will then be presented with a simple slider to make your contrast adjustments. When you're finished, you can click on the cross of the slider window. Your new contrast value is automatically saved within the *DCA Pro*.

## Audible Settings

Your *DCA Pro* has a built-in sounder for alerting you to various test results and conditions. Additionally, the sounder produces short tones to reinforce the tactile feedback when pressing buttons.



Here is a summary of the various tone types:

Condition	Tone Type
Power-up.	Rising 3 notes.
Power-down, including auto-off.	Falling 3 notes.
Button press.	Very short “blip”.
Component detected.	Short Low-High.
Faulty, unknown or no part detected.	Long High-Low.

If you wish, you can switch the audible alerts on or off.

To change the current setting for audible alerts, while the unit is already on, simply press and hold the **on-test** button for a few seconds.

The new sound setting will then be confirmed on the screen.

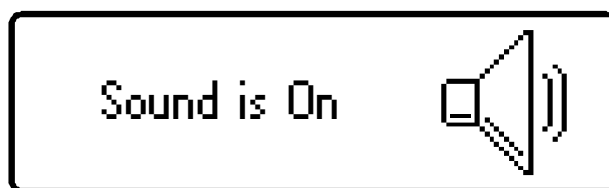

To change back again, simply press and hold the **on-test** button again for a few seconds.

## Care of your *Atlas DCA Pro*

Your *DCA Pro* should provide many years of service if used in accordance with this user guide. Care should be taken not to expose your unit to excessive heat, shock or moisture. Additionally, the battery should be replaced at least every 12 months to reduce the risk of leak damage.



Please replace  
the battery.



If a low battery warning message appears, immediate replacement of the battery is required.

The battery can be replaced by carefully opening the *DCA Pro* by removing the three screws from the rear of the unit. Take care not to damage the electronics.

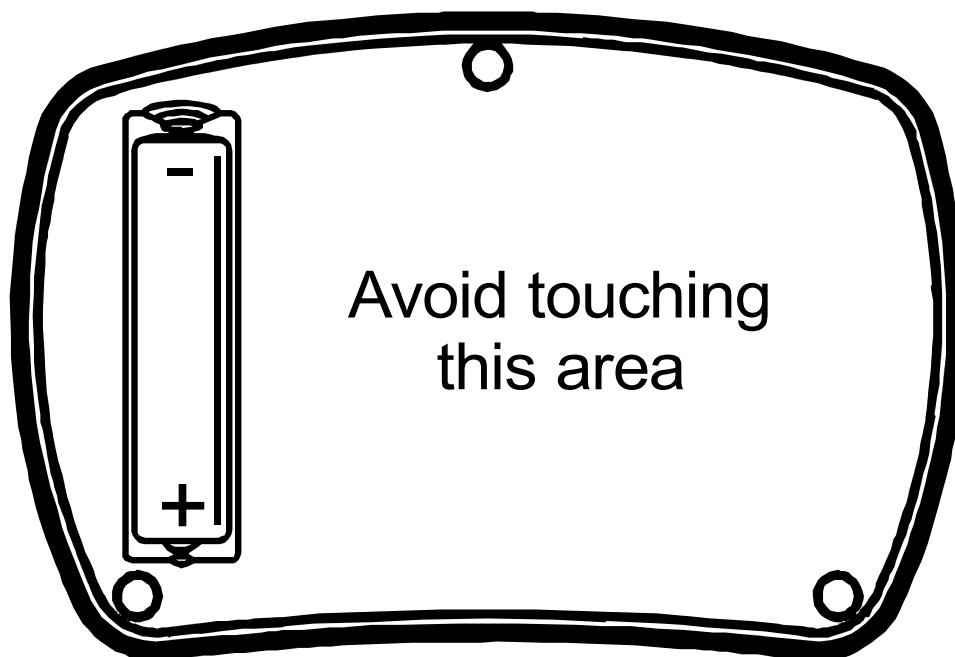

We recommend that the battery is replaced with a high quality battery equivalent to an **Alkaline AAA**, LR03 or MN2400 (1.5V). Replacement Alkaline AAA batteries are available from many retail outlets.

**DO NOT OVER-TIGHTEN THE SCREWS**

## Self Test Procedure

Each time the *DCA Pro* is powered up, a self test procedure is performed. In addition to a battery voltage test, the unit measures the performance of many internal functions such as the voltage and current sources, amplifiers, analogue to digital converters and test lead multiplexers. If any of these function measurements fall outside tight performance limits, a message will be displayed and the instrument will switch off automatically.

If the problem was caused by a temporary condition on the test clips, such as applying power to the test clips, then simply re-starting the unit may clear the problem.

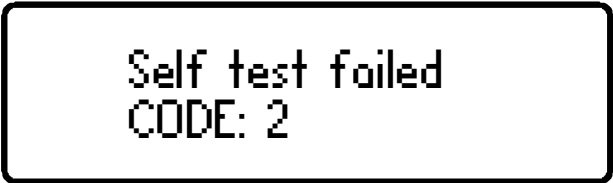

Self test failed  
CODE: 2

If a persistent problem does arise, it is likely that damage has been caused by an external event such as excessive power being applied to the test clips. If the problem persists, please contact us for further advice, quoting the displayed fault code.



If there is a low battery condition, the automatic self test procedure will not be performed. For this reason, it is highly recommended that the battery is replaced as soon as possible following a low battery warning.

## Appendix A – Troubleshooting

### First thing to do:

It is important that you ensure you've got the latest version of firmware (software that's inside the *DCA Pro* instrument) and the latest version of PC software. You can do this by connecting the unit to your PC and selecting the "Help" menu and then click on "Check for Updates".

It is possible that a firmware update and/or a PC software update will resolve your problem.

Here's a further guide to helping you with your *DCA Pro* if you're having problems:

Problem	Possible Solutions
PC software always says "Disconnected" even when the <i>DCA Pro</i> is connected and powered up.	Unplug USB, wait a few seconds and plug back in. Try a different USB socket on your PC. Restart your PC. Re-install DCA Pro software
Unit displays <b>Boost timeout</b> .	It is possible that your battery is in poor condition. Replace with a new Alkaline AAA battery.
Measured parameters don't agree with the component datasheet.	Most semiconductors have very wide tolerances and even identical transistor types can show huge gain variation between them. Characteristics shown in datasheets may be specified at different test conditions compared to the test conditions used by the <i>DCA Pro</i> .

Much more help is available at [www.peakelec.co.uk/content/support.html](http://www.peakelec.co.uk/content/support.html)

Feel free to contact us for technical assistance. Our contact details are shown at the end of this user guide.

## Appendix B – Summary Technical Specifications

All values are at 25°C unless otherwise specified. Specifications subject to change.

Parameter	Min	Typ	Max	Note
<b>Bipolar Transistors</b>				
Measurable current gain ( $H_{FE}$ ) range	2		32000	2
$H_{FE}$ accuracy ( $H_{FE} < 2000$ )	$\pm 3\% \pm 5 H_{FE}$			2,8
$H_{FE}$ test voltage ( $V_{CEO}$ )	3.0V		9.0V	2
$H_{FE}$ collector test current	4.75mA	5.00mA	5.25mA	
Base current for $V_{BE}$ measurement	4.75mA	5.00mA	5.25mA	
$V_{BE}$ accuracy	$\pm 1\% \pm 0.006V$			8
$V_{BE}$ resolution		3.0mV	6.0mV	
$V_{BE}$ for Darlington identification	0.95V	1.00V	1.80V	3
$V_{BE}$ for Darlington (shunted types)	0.75V	0.80V	1.80V	4
$V_{BE}$ threshold for germanium		0.55V		
Acceptable $V_{BE}$			1.80V	
Base-emitter shunt threshold	50k $\Omega$	60k $\Omega$	70k $\Omega$	
Acceptable collector leakage			1.5mA	6
Leakage current accuracy	$\pm 2\% \pm 0.02mA$			
<b>MOSFETs/IGBTs</b>				
Enhancement mode $V_{GS(ON)}$ range	0.0V		10.0V	5
Depletion mode $V_{GS(ON)}$ range	-5.0V		0.0V	5
$V_{GS(ON)}$ accuracy	$\pm 2\% \pm 0.01V$			5
Drain current at $V_{GS(ON)}$	4.75mA	5.00mA	5.25mA	
Drain-Source voltage at $V_{GS(ON)}$	3.5V		9.0V	5
Acceptable gate-source resistance	8k $\Omega$			
IGBT collector saturation threshold		0.40V		9
<b>JFETs</b>				
Pinch-off $V_{GS(OFF)}$ range	-10.0V		2.5V	
Pinch-off drain-source current	0.5 $\mu$ A	1.0 $\mu$ A	2.0 $\mu$ A	
Turn-on $V_{GS(ON)}$ range	-9.0V		2.5V	
Turn-on drain-source test current	4.75mA	5.00mA	5.25mA	
$V_{GS}$ accuracy	$\pm 2\% \pm 0.01V$			
Transconductance ( $g_{fs}$ ) range			99mA/V	
$g_{fs}$ test drain current span	3.0mA to 5.0mA			
$g_{fs}$ accuracy (<20mA/V)	$\pm 5\% \pm 2mA/V$			
$g_{fs}$ accuracy (>20mA/V)	$\pm 10\% \pm 5mA/V$			

## Summary Technical Specifications continued:

All values are at 25°C unless otherwise specified. Specifications subject to change.

Parameter	Min	Typ	Max	Note
<b>Thyristors and Triacs</b>				
Gate trigger test current	8.0mA	10.0mA	12.0mA	7
Load hold test current		10.0mA	15.0mA	
<b>Diodes and LEDs</b>				
Diode forward test current	4.75mA	5.00mA	5.25mA	
Diode forward voltage accuracy	±1% ±0.006V			
Acceptable $V_F$ for a diode @ 5mA	0.15V			
$V_F$ for LED identification	1.50V		4.00V	
<b>Zener Diodes</b>				
Zener voltage range at 5mA	1.8V		9.0V	
Zener voltage range below 5mA		9.0V	12.0V	
Zener diode test current	0.50mA	5.00mA	5.25mA	
<b>Voltage Regulators</b>				
Input test voltage range ( $I_Q < 3.0mA$ )	1.10V		10.0V	
Input test voltage range ( $I_Q < 5.0mA$ )			8.0V	
Quiescent current range ( $I_Q$ )	0.00mA		5.00mA	
Quiescent current accuracy	±2% ±0.02mA			
Dropout voltage range ( $V_{DO}$ )	0.00V		3.00V	
Dropout voltage accuracy	±2% ±0.02V			
Output voltage accuracy	±1% ±0.006V			
Load test current	0.13mA		1.25mA	
<b>General Parameters</b>				
Peak test current into S/C	-15.5mA		15.5mA	1
Peak test voltage across O/C	-13.5V		13.5V	1
Short circuit threshold	5Ω	10Ω	20Ω	1
Battery type	1 x AAA, LR03, MN2400, Alkaline 1.5V			
Battery voltage range	1.00V	1.50V	1.60V	
Battery warning threshold		1.00V		
USB current consumption	500mA peak active. ≤2mA sleep.			
Dimensions (body)	103 x 70 x 20 mm			

- Between any pair of test clips.
- Collector current of 5.0mA. Gain accuracy valid for gains less than 2000.
- Resistance across reverse biased base-emitter > 60kΩ.
- Resistance across reverse biased base-emitter < 60kΩ.
- Load current of 5.0mA.
- Collector-emitter voltage of 10.0V.
- Thyristor quadrant I, Triac quadrants I and III.
- BJT with no shunt resistors.
- Load current typically 10.0mA.



## Appendix C – Analysis Test Circuits

The *DCA Pro* analyses components by applying signals to the component under test while in a “test circuit”. The test circuits that the *DCA Pro* uses to analyse various components are shown below.

These test circuits are presented here to assist in your understanding of the test conditions that are possible when testing in standalone mode and in the PC mode (for curve tracing etc).

### Transistor Test Circuit

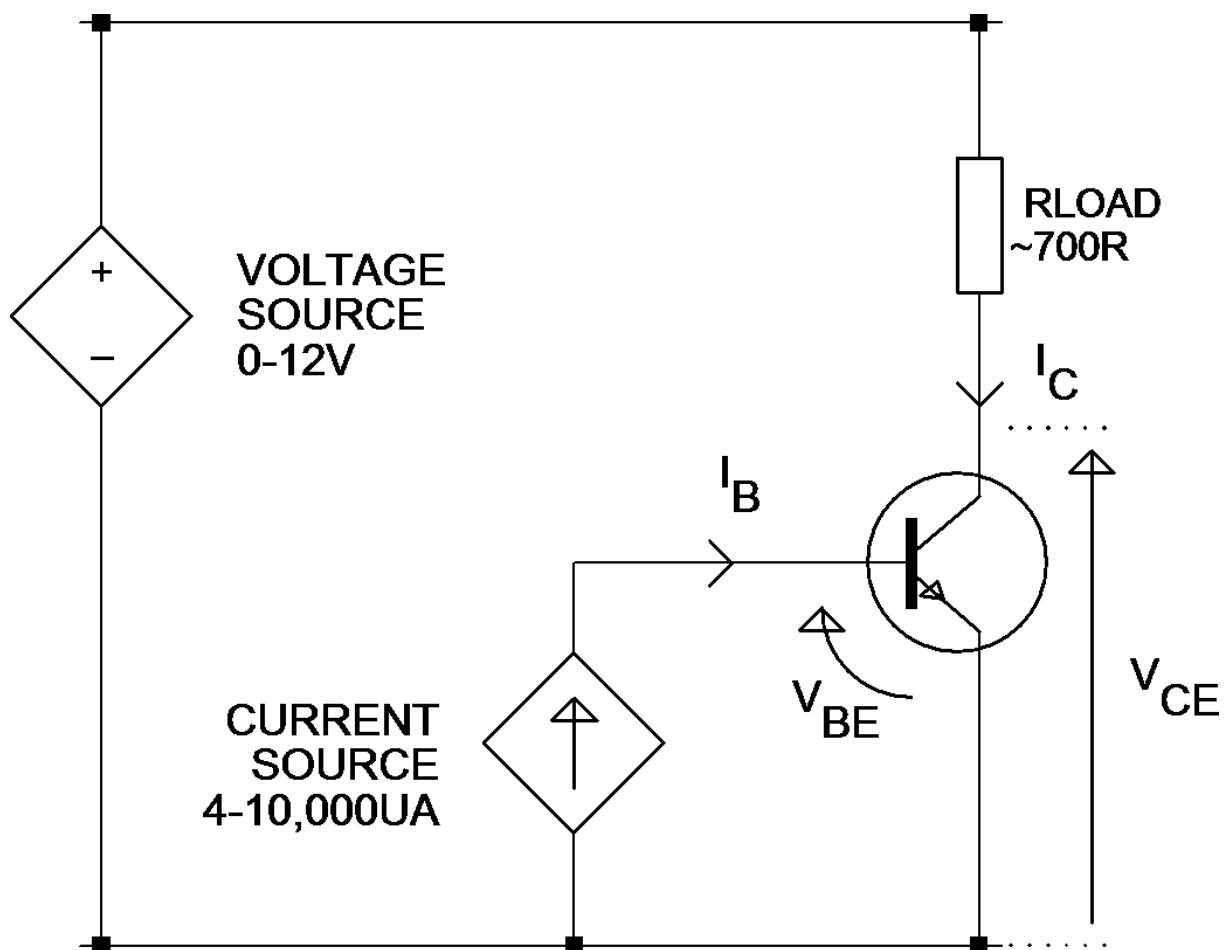

Example shown is for an NPN transistor. Polarities are reversed for PNP devices.

## JFET/MOSFET/IGBT Test Circuit

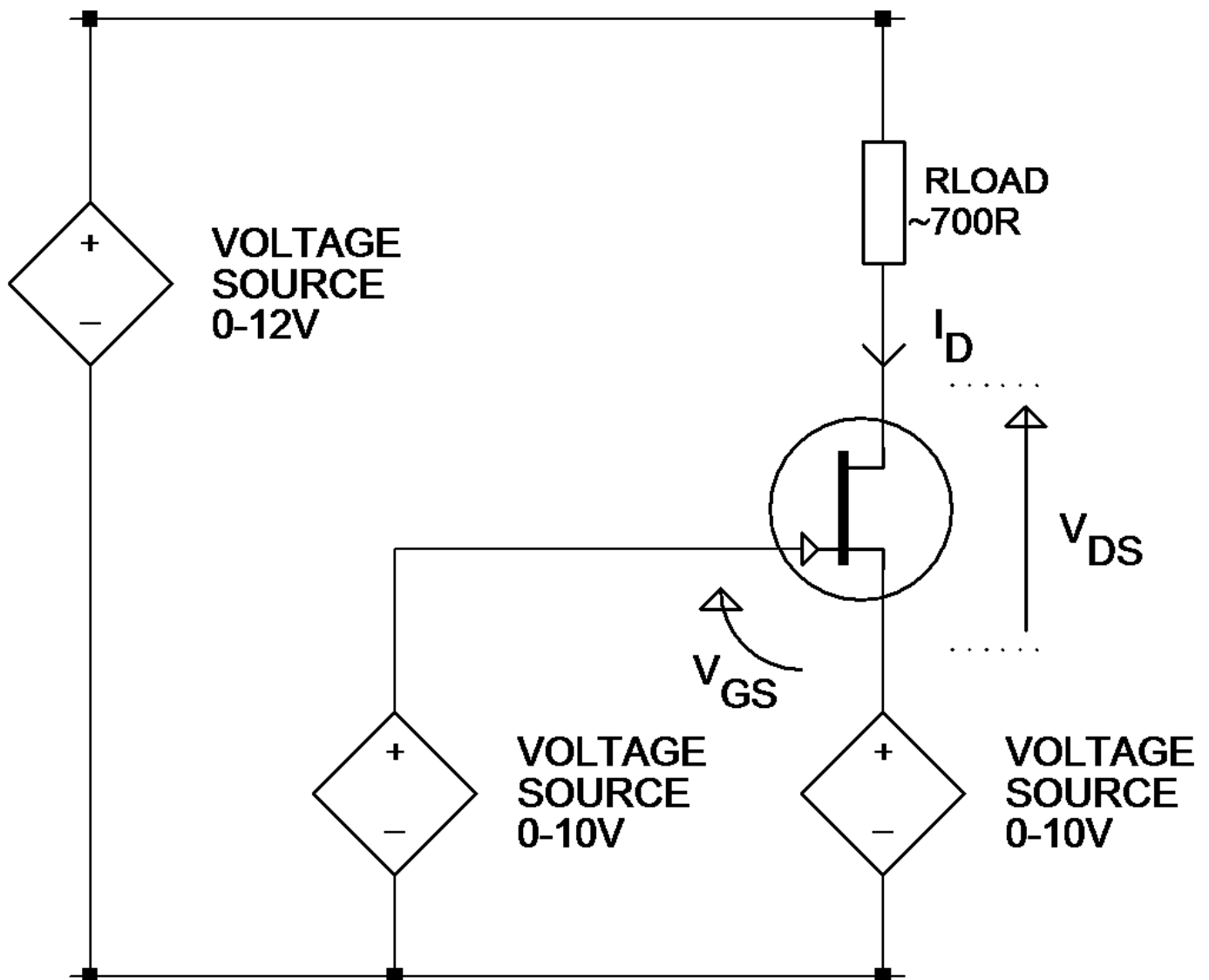

It's important to note that the gate-source voltage can be driven negative by making the source voltage drive higher than the gate voltage drive. When this is done however, there is less voltage available to be across the drain-source nodes and the load resistor.

Example shown is for an N-Channel JFET. Polarities are reversed for P-Channel devices.

## Diode Test Circuit

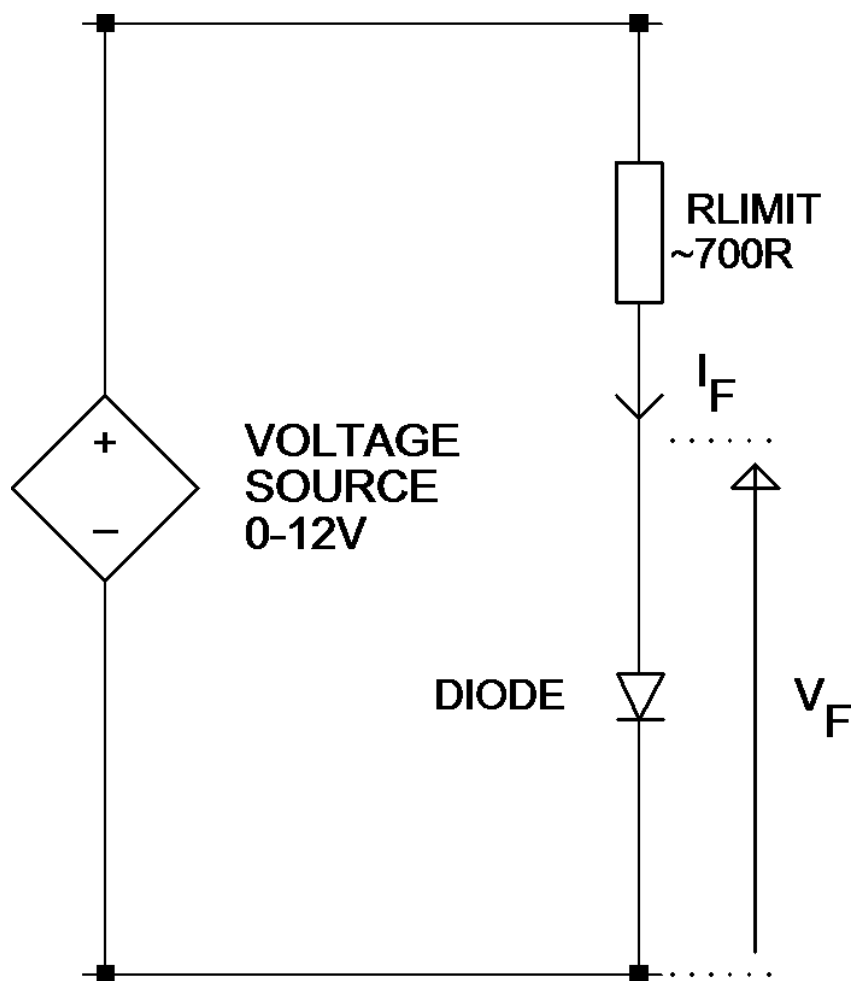

This test circuit is used for testing both the forward and reverse characteristics of diodes. Reverse characteristics are particularly useful for the testing of Zener diodes.

For the standalone mode, the voltage is automatically adjusted to obtain a “target” current of 5mA. For Zener diodes that have a breakdown voltage of more than about 9V, the target current of 5mA cannot be obtained.

## Voltage Regulator Test Circuit

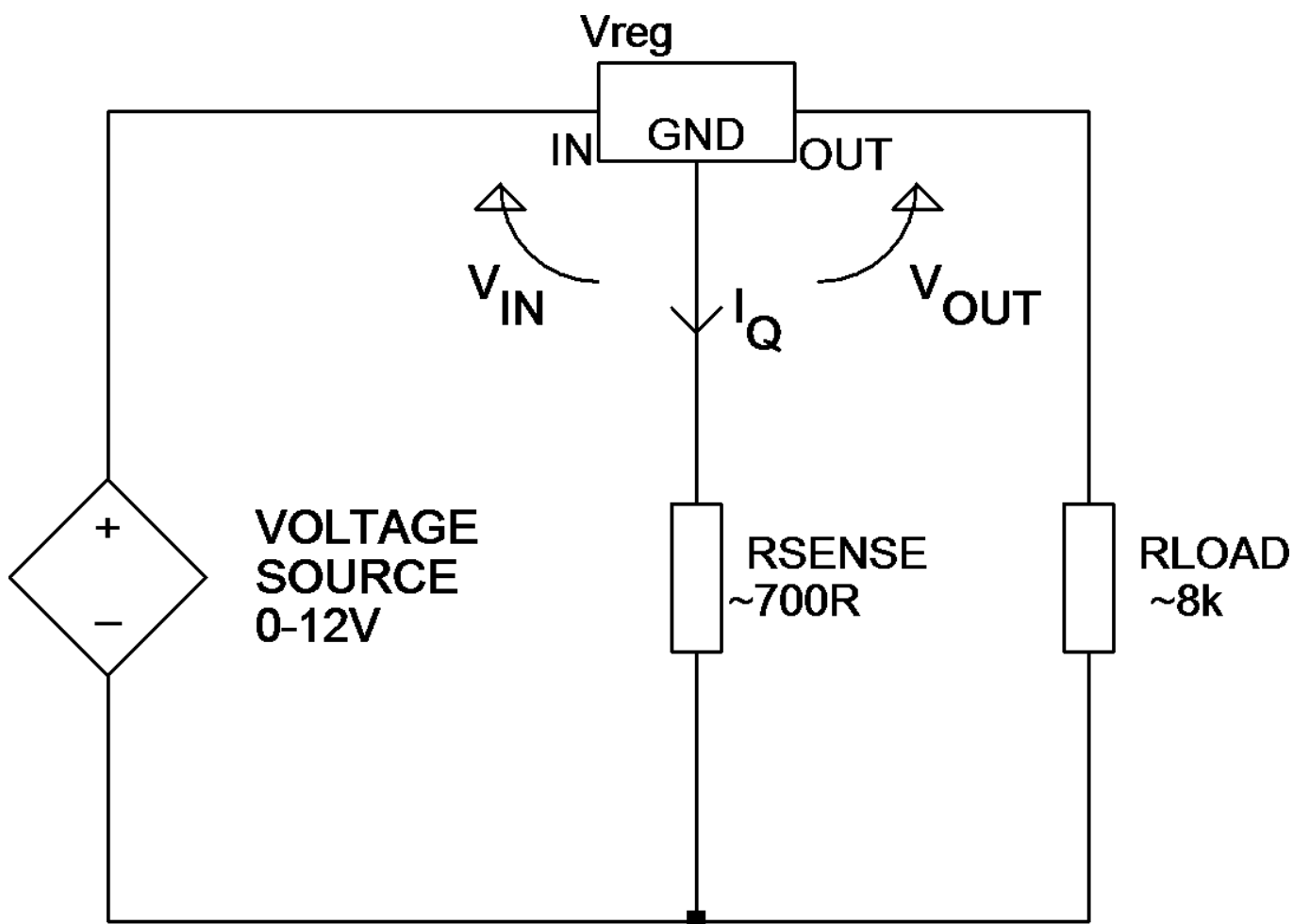

The test circuit shown here is used for the analysis of voltage regulators (positive regulators in this example). Note that the range of regulator voltages supported will depend on the quiescent current ( $I_Q$ ). A higher quiescent current will cause more voltage to be dropped across the sense resistor and yield less voltage for the regulator itself.

Note also that some voltage regulators, particularly low dropout types (LDO), are not stable when tested by the *DCA Pro*.

## Appendix D – Warranty Information

### Peak Satisfaction Guarantee

If for any reason you are not completely satisfied with your *DCA Pro* within 14 days of purchase you may return the unit to your distributor. You will receive a refund covering the full purchase price if the unit is returned in perfect condition.

### Peak Warranty

The warranty is valid for 24 months from date of purchase. This warranty covers the cost of repair or replacement due to defects in materials and/or manufacturing faults.

The warranty does not cover malfunction or defects caused by:

- a) Operation outside the scope of the user guide.
- b) Unauthorised access or modification of the unit (except for battery replacement).
- c) Accidental physical damage or abuse.
- d) Normal wear and tear.

The customer's statutory rights are not affected by any of the above.

All claims must be accompanied by a proof of purchase.

## Appendix E – Disposal Information



### **WEEE (Waste of Electrical and Electronic Equipment), Recycling of Electrical and Electronic Products**

#### **United Kingdom**

In 2006 the European Union introduced regulations (WEEE) for the collection and recycling of all waste electrical and electronic equipment. It is no longer permissible to simply throw away electrical and electronic equipment. Instead, these products must enter the recycling process.

Each individual EU member state has implemented the WEEE regulations into national law in slightly different ways. Please follow your national law when you want to dispose of any electrical or electronic products.

**More details can be obtained from your national WEEE recycling agency.**

If in doubt, you may send your Peak Product to us for safe and environmentally responsible disposal.

At Peak Electronic Design Ltd we are committed to continual product development and improvement.  
The specifications of our products are therefore subject to change without notice.

© 2012/2014 Peak Electronic Design Limited - E&OE  
Designed and manufactured in the UK  
www.peakelec.co.uk Tel. +44 (0) 1298 70012 Fax. +44 (0) 1298 70046