

Total solder points: 74

Difficulty level: *beginner* 1 2 3 4 5 *advanced*

MULTI-TONE CHIME

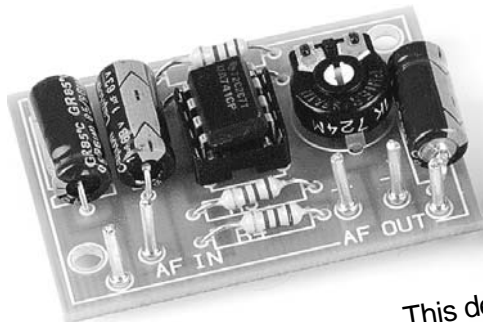

K6600

This device is a simple and economic way of generating electronic tones. This kit is primarily intended for use as a replacement for the traditional mechanical doorbell.

SPECIFICATIONS:

- For use in homechime, call systems, games or discobars.
- One, two or three tones triggered by 3 different push buttons.
- Adjustable tone and volume control.
- Peak output power: 0.3W (8 Ohm speaker).
- Power Supply: 6 to 9VAC/0.2A or 4.5V battery (3 x 1.5V).
- Standby current: less than 10 μ A.
- Dimensions (WxDxH): 53x59x25mm.
- Usable housings: WCAH2851, G416, G410
- Usable battery holder: BH331B

modifications reserved

1. Assembly (Skipping this can lead to troubles !)

Ok, so we have your attention. These hints will help you to make this project successful. Read them carefully.

1.1 Make sure you have the right tools:

- A good quality soldering iron (25-40W) with a small tip.
- Wipe it often on a wet sponge or cloth, to keep it clean; then apply solder to the tip, to give it a wet look. This is called 'thinning' and will protect the tip, and enables you to make good connections. When solder rolls off the tip, it needs cleaning.
- Thin rosin-core solder. Do not use any flux or grease.
- A diagonal cutter to trim excess wires. To avoid injury when cutting excess leads, hold the lead so they cannot fly towards the eyes.
- Needle nose pliers, for bending leads, or to hold components in place.
- Small blade and Phillips screwdrivers. A basic range is fine.

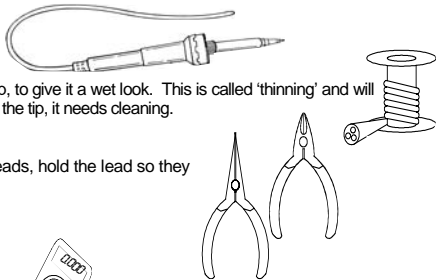

For some projects, a basic multi-meter is required, or might be handy

**1.2 Assembly Hints :**

- ⇒ Make sure the skill level matches your experience, to avoid disappointments.
 - ⇒ Follow the instructions carefully. Read and understand the entire step before you perform each operation.
 - ⇒ Perform the assembly in the correct order as stated in this manual
 - ⇒ Position all parts on the PCB (Printed Circuit Board) as shown on the drawings.
 - ⇒ Values on the circuit diagram are subject to changes.
 - ⇒ Values in this assembly guide are correct*
 - ⇒ Use the check-boxes to mark your progress.
 - ⇒ Please read the included information on safety and customer service
- * Typographical inaccuracies excluded. Always look for possible last minute manual updates, indicated as 'NOTE' on a separate leaflet.

1.3 Soldering Hints :

1- Mount the component against the PCB surface and carefully solder the leads

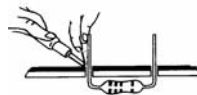

2- Make sure the solder joints are cone-shaped and shiny

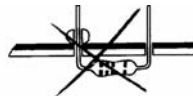

3- Trim excess leads as close as possible to the solder joint



REMOVE THEM FROM THE TAPE ONE AT A TIME !

**AXIAL COMPONENTS ARE TAPED IN THE
CORRECT MOUNTING SEQUENCE !**

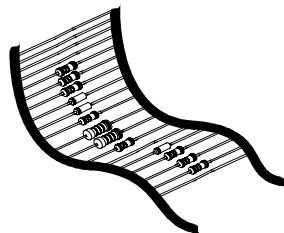

You will find the color code for the resistances and the LEDs on our website:
<http://www.velleman.be/common/service.aspx>

1. Resistors

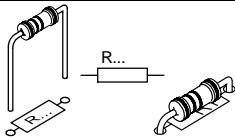

- R1 : 10K (1 - 0 - 3 - B)
- R2 : 10K (1 - 0 - 3 - B)
- R3 : 10K (1 - 0 - 3 - B)
- R4 : 10K (1 - 0 - 3 - B)
- R5 : 1K (1 - 0 - 2 - B)
- R6 : 220 (2 - 2 - 0 - B)

2. Diodes. Watch the polarity !

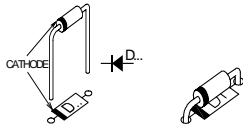

- D1 : 1N4148
- D2 : 1N4148
- D3 : 1N4007
- D4 : 1N4007

- D5 : 1N4007
- D6 : 1N4007
- D7 : 1N4007
- D8 : 1N4007

3. Zenerdiode. Watch the polarity !

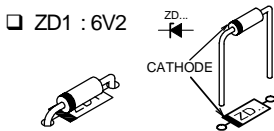

4. IC socket, Watch the position of the

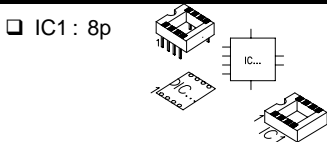

- IC1 : 8p

5. Capacitors.

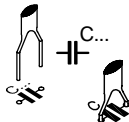

- C1 : 4n7 (472)
- C2 : 100nF (104)
- C3 : 100nF (104)

6. Trim potentiometers

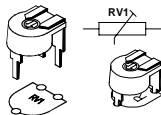

- RV1 : 22K
- RV2 : 22K

7. Transistors

- T1 : BC337 or eq

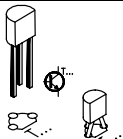

8. PCB pins

- AC
- LS
- SW1
- SW2
- SW3

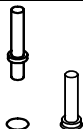

9. Electrolytic Capacitors. Watch the polarity !

- C4 : 10 μ F
- C5 : 470 μ F
- C6 : 470 μ F

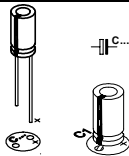

10. IC mounting

- IC1 : SAE800

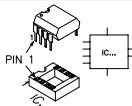

☞ Pay attention to the position of the notch!

11. Connection of battery as supply

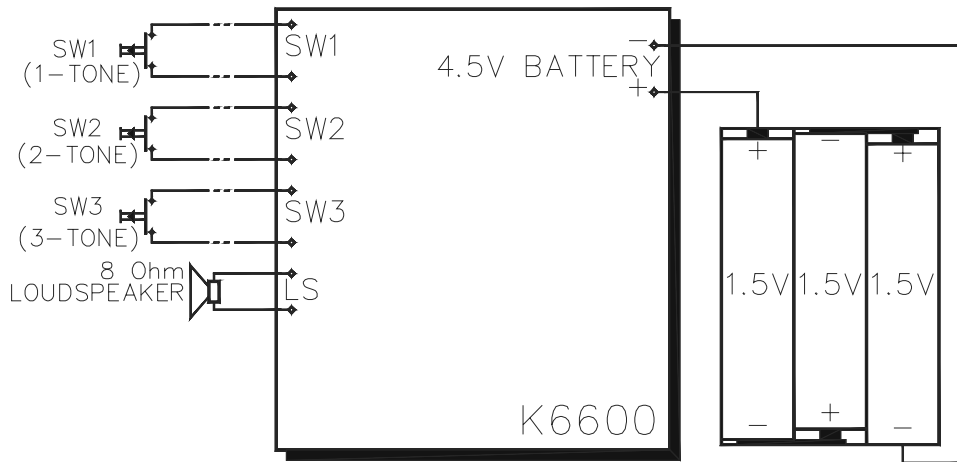

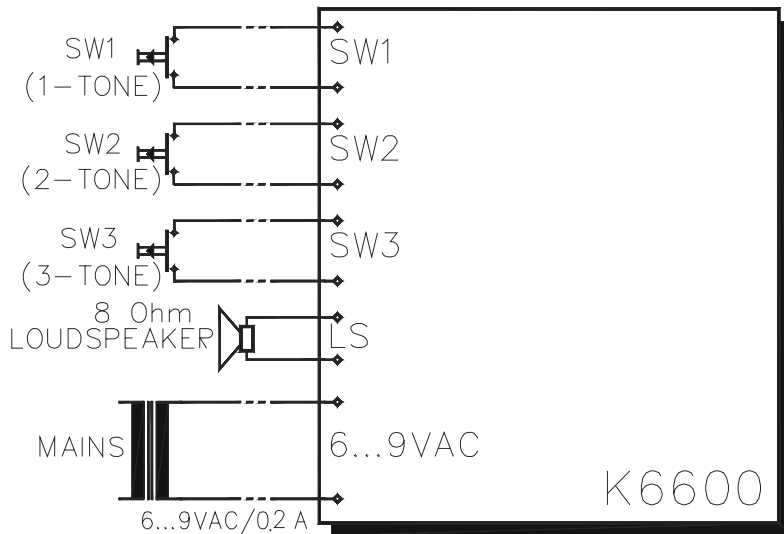
12. Connection of transformer as supply

13. Connecting a transformer and backup battery supply

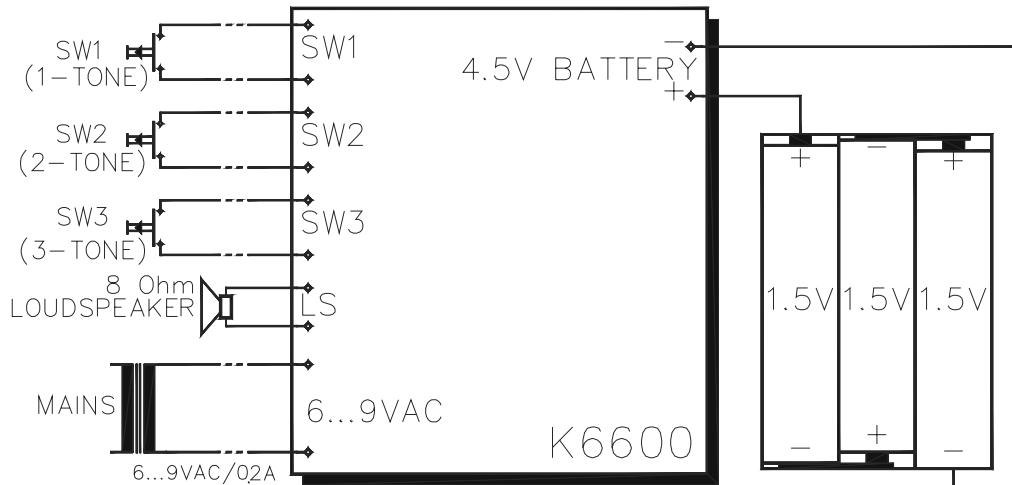

15. PCB

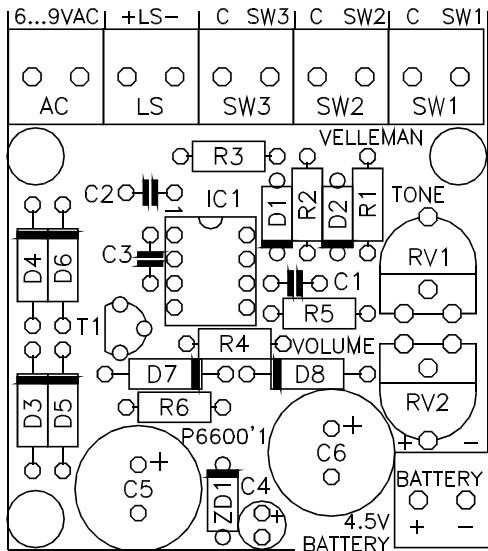



Modifications and typographical errors reserved
© Velleman Components nv.
H6600IP - 2007 - ED1

